



# GeKaMac®















## **Power TIG 3200 AC/DC DC Pulse Users Manual**



Please Read and Understand This Manual  
Before Operating The Welding Machine





[www.gedikwelding.com](http://www.gedikwelding.com)

## Safety rules

|                                       |   |  |
|---------------------------------------|---|--|
| Danger!                               |    | “Danger” indicates an imminently hazardous situation which, if not avoided, will result in death or serious injury.  |
| Warning!                              |    | “Warning!” indicates a possible hazardous situation which, if not avoided, could result in death or serious injury. The possible hazards are explained in the text.  |
| Caution!                              |    | “Caution” indicates a possible hazardous situation which, if not avoided, may result in slight or moderate injury.   |
| Note!                                 |    | “Note!” indicates a situation which implies a risk of impaired welding result and damage to the equipment.   |
| Important!                            |   | “Important!” indicates practical tips and other useful special-message. It is no signal word for a harmful or dangerous situation.   |
| Utilisation for intended purpose only |    | <ul style="list-style-type: none"> <li>• The machine may only be used for jobs as defined by the “Intended purpose”.</li> <li>• Utilisation for any other purpose, or in any other manner, shall be deemed to be “not in accordance with the intended purpose”. The manufacturer shall not be liable for any damage resulting from such improper use.</li> </ul>   |
| Safety signs                          |  | <ul style="list-style-type: none"> <li>• All the safety instructions and danger warnings on the machine must be kept in legible condition, not removed, not be covered, pasted or painted cover.</li> </ul>  |
| Safety inspection                     |  | <ul style="list-style-type: none"> <li>• The owner/operator is obliged to perform safety inspection at regular intervals.</li> <li>• The manufacturer also recommends every 3-6 months for regular maintenance of power sources.</li> </ul>  |
| Safety markings                       |  | Equipment with CE-markings fulfils the basic requirements of the Low-Voltage and Electromagnetic Compatibility Guideline (e.g. relevant product standards according to EN 60 974).   |
|                                       |  | Equipment with CCC markings meets the requirements of implementations rules for China compulsory certification.  |
| Electric shock can kill               |  | <ul style="list-style-type: none"> <li>• Touching live electrical parts can cause fatal shocks or severe burns. The electrode and work circuit is electrically live whenever the output is on. The input power circuit and machine internal circuits are also live when power is on. In MIG/MAG welding, the wire, drive rollers, wire feed housing and all metal parts touching the welding wire are electrically live. Incorrectly installed or improperly grounded equipment is a hazard.</li> <li>• Do not touch live electrical parts of the welding circuit, electrodes and wires with your bare skin or wet clothing.</li> <li>• The operator must wear dry hole-free insulating welding gloves and body</li> </ul> |

|  |   |  |
|--|---|--|
|  |   | <p>protection while performs the welding.</p> <ul style="list-style-type: none"> <li>• Insulate yourself from work and ground using dry insulating protection which is large enough to prevent you full area of physical contact with the work or ground.</li> <li>• Connect the primary input cable according to rules. Disconnect input power or stop machine before installing or maintenance.</li> <li>• If welding must be performed under electrically hazardous conditions as follow: in damp locations or wearing wet clothing; on metal structures such as floors, gratings, or scaffolds; when in cramped positions such as sitting, kneeling, or lying; or in occasion when there is a high risk of unavoidable or accidental contact with the work piece or ground. Must use additional safety precautions: semiautomatic DC constant voltage (wire) welder, DC manual (Stick) welder and AC welder with reduced open-load voltage.</li> <li>• Maintain the electrode holder, ground clamp, welding cable and welding machine in good, safe operating condition. Replace damaged part immediately.</li> </ul>  |
| <p>Electric and magnetic fields (EMF) may be dangerous</p> |    | <ul style="list-style-type: none"> <li>• If electromagnetic interference is found to be occurring, the operator is obliged to examine any possible electromagnetic problems that may occur on equipment as follow: <ul style="list-style-type: none"> <li>- minas, signal and data-transmission leads</li> <li>- IT and telecoms equipment</li> <li>- measurement and calibration devices</li> <li>- Wearers of pacemakers</li> </ul> </li> <li>• Measures for minimizing or preventing EMC problems: <ul style="list-style-type: none"> <li>- Mains supply</li> </ul> <p>If electromagnetic interference still occurs, despite the fact that the mains connection in accordance with the regulations, take additional measures</p> <ul style="list-style-type: none"> <li>- Welding cables</li> </ul> <p>Keep these as short as possible</p> <p>Connect the work cable to the work piece as close as possible to the area being welded.</p> <p>Lay tem well away from other cables.</p> <p>Do not place your body between your electrode and work cables.</p> <ul style="list-style-type: none"> <li>- Equipotential bonding</li> <li>- Workpiece grounding (earthing)</li> <li>- Shielding</li> </ul> <p>Shield the entire welding equipment and other equipment nearby.</p> </li> </ul> |
| <p>ARC rays can burn.</p>                                  |  | <ul style="list-style-type: none"> <li>• Visible and invisible rays can burn eyes and skin.</li> <li>• Wear an approved welding helmet or suitable clothing made from durable flame-resistant material (leather, heavy cotton, or wool) to protect your eyes and skin from arc rays and sparks when welding or watching.</li> <li>• Use protective screens or barriers to protect other nearby personnel with suitable, non-flammable screening and/or warn them not to watch the arc nor expose themselves to the arc rays or to hot spatter or material.</li> </ul>  |

|  |   |   |
|--|---|---|
| <p>Fumes and gases can be dangerous</p>                        |    | <ul style="list-style-type: none"> <li>• Welding may produce fumes and gases, breathing these fumes and gases can be hazardous to your health.</li> <li>• When welding, keep your head out of the fume. If inside, ventilate the area at the arc to keep fumes and gases away from the breathing zone. If ventilation is not good, wear an approved air-supplied respirator.</li> <li>• Work in a confined space only if it is well ventilated, or while wearing an air-supplied respirator.</li> <li>• Welding fumes and gases can displace air and lower the oxygen level causing injury or death. Always use enough ventilation, especially in confined areas, to insure breathing air is safe.</li> </ul>   |
| <p>Welding and cutting sparks can cause fire or explosion.</p> |    | <ul style="list-style-type: none"> <li>• When not welding, make sure the electrode circuit is not touching the work or ground. Accidental contact can cause sparks, explosion, overheating, or fire. Make sure the area is safe before doing any welding.</li> <li>• Welding and cutting on closed containers, such as tanks, drums, or containers, can cause them to blow up. Make sure proper steps have been taken.</li> <li>• When pressure gas is used at the work site, special precautions are required to prevent hazardous situations.</li> <li>• Connect work cable to the work as close to the welding zone as practical to prevent welding current from passing too long and creating fire hazards or overheat.</li> <li>• Wear oil-free protective garments such as leather gloves, heavy shirt, cuffless trousers, high shoes, and a cap. Wear ear plugs when welding out of position or in confined places. Always wear safety glasses with side shields when in a welding area.</li> <li>• Be attention that welding sparks and hot materials from welding can easily go through small cracks and openings to adjacent areas and start a fire. Remove fire hazardous from the welding area, if not possible, cover them thoroughly. Do not weld where flying sparks can strike flammable material and where the atmosphere may contain flammable dust, gas, or liquid vapors (such as gasoline).</li> <li>• Protect yourself and others from flying sparks and hot metal. Remove any combustibles from operator before perform any welding.</li> <li>• Keep a fire extinguisher readily available.</li> <li>• Empty containers, tanks, drums, or pipes which have combustibles before perform welding.</li> <li>• Remove stick electrode from electrode holder or cut off welding wire at contact tip when not in use.</li> <li>• Apply correct fuses or circuit breakers. Do not oversize or bypass them.</li> </ul> |
| <p>Cylinder can explode if damaged.</p>                        |  | <ul style="list-style-type: none"> <li>• Pressure gas cylinders contain gas under high pressure. If damaged, a cylinder can explode. Since gas cylinders are normally part of the welding process, be sure to treat them carefully.</li> <li>• Cylinders should be located away from areas where they may be struck or</li> </ul>   |

|                                      |   |   |
|--------------------------------------|---|---|
|                                      |   | <p>subjected to physical damage. Use proper equipment, procedures, and sufficient number of persons to lift and move cylinders.</p> <ul style="list-style-type: none"> <li>• Always install cylinders in an upright position by securing to a stationary support or cylinder rack to prevent falling over or tipping.</li> <li>• Keep a safe distance from arc welding or cutting operations and any other source of heat, sparks, or flame.</li> <li>• No touching cylinder by welding electrode, electrode holder or any other electrically “hot” parts. Do not drape welding cables or welding torches over a gas cylinder.</li> <li>• Use only correct compressed gas cylinders, regulators, hoses, and fittings designed for the process used; maintain them and associated parts in good condition.</li> <li>• Use only compressed gas cylinders containing the correct shielding gas for the and properly operating regulators designed for the gas and pressure used. All hoses, fittings, etc. should be suitable for the application and maintained in good condition.</li> <li>• Open the cylinder valve slowly and keep your head and face away from the cylinder valve outlet.</li> <li>• Valve protection caps should be kept in place over valve except when the cylinder is in use or connected for use.</li> </ul> |
| Hot parts can burn                   |  | <ul style="list-style-type: none"> <li>• Do not touch hot parts with bare hand or skin.</li> <li>• Ensure equipment is cooled down before perform any work.</li> <li>• If touching hot parts is needed, use proper tools and/or wear heavy, insulated welding gloves and clothing to prevent burns.</li> </ul>  |
| Flying metal or dirt can injure eyes |  | <ul style="list-style-type: none"> <li>• When welding, chipping, wire brushing, and grinding can cause sparks and flying metal. It can hurt your eyes.</li> <li>• Remember wear appropriate safety glasses with side shields when in welding zone, even under your welding helmet.</li> </ul>   |
| Noise can damage hearing             |  | <ul style="list-style-type: none"> <li>• Noise from some processes or equipment can damage hearing.</li> <li>• Remember wear approved ear protection to protect ears if noise level is high.</li> </ul>   |
| Moving parts can injure              |  | <ul style="list-style-type: none"> <li>• Stay away from moving parts such as fans.</li> <li>• Stay away from pinch points such as drive rolls.</li> <li>• Keep all doors, panels, covers, and guards closed and securely in place.</li> <li>• Have only qualified persons remove doors, panels, covers, or guards for servicing and maintenance.</li> <li>• Reinstall doors, panels, covers, or guards when servicing and maintenance is finished and before reconnecting input power.</li> </ul>   |
| Overuse can cause overheating        |  | <ul style="list-style-type: none"> <li>• Use machine follow duty cycle. Reduce current or reduce duty cycle before starting to weld again.</li> <li>• Allow cooling period.</li> <li>• Do not block or filter airflow to unit.</li> </ul>   |

## Contents

|  |    |
|--|----|
| 1-GENERAL REMARKS.....                         | 7  |
| 1-1 Power source features.....                 | 7  |
| 1-2 Functional principle.....                  | 7  |
| 1-3 Output characteristics.....                | 7  |
| 1-4 Duty cycle.....                            | 8  |
| 1-5 Applications.....                          | 8  |
| 1-6 Warning label.....                         | 8  |
| 2- VERSIONS BRIEFS.....                        | 9  |
| 3- BEFORE COMMISSIONING.....                   | 10 |
| 3-1 Utilization for intended purpose only..... | 10 |
| 3-2 Machines set-up regulations.....           | 10 |
| 3-3 Power source connection.....               | 10 |
| 3-4 Welding cables instruction.....            | 10 |
| 4- Power TIG 3200 AC/DC DC Pulse.....          | 12 |
| 4-1 System components.....                     | 12 |
| 4-2 Basic equipments for welding.....          | 12 |
| 4-3 Control panel.....                         | 13 |
| 4-4 Interface.....                             | 23 |
| 4-5 Water-cooling system.....                  | 25 |
| 4-6 Installation and operation.....            | 25 |
| 4-7 Technical data.....                        | 33 |
| 4-8 Main components list.....                  | 35 |

|  |   |    |
|--|---|----|
| 5- Power TIG 3200 AC/DC DC Pulse . . . . .         | <b>Hata! Yer işareti tanımlanmamış.</b> | 38 |
| 5-1 System components . . . . .                    |   | 38 |
| 5-2 Basic equipments for welding. . . . .          |   | 38 |
| 5-3 Control panel. . . . .                         |   | 38 |
| 5-4 Interface . . . . .                            |   | 53 |
| 5-5 Water-cooling system . . . . .                 |   | 53 |
| 5-6 Installation and operation . . . . .           |   | 54 |
| 5-7 Technical data . . . . .                       |   | 54 |
| 5-8 Main components list . . . . .                 |   | 56 |
| 6-TROUBLE SHOOTING . . . . .                       |   | 58 |
| 7-CARE AND MAINTENANCE. . . . .                    |   | 59 |
| 8- WELDING TECHNIQUE GUIDE. . . . .                |   | 60 |
| 8-1 TIG (GTAW) basic welding technique. . . . .    |   | 60 |
| 8-2 STICK (SMAW) basic welding technique . . . . . |   | 64 |

# 1-GENERAL REMARKS

## 1-1 Power source features

This series of power sources are microprocessor controlled and apply MCU + DSP control technology to improve the control precision. The strong ability of arc self- adjustment ensures a highly stable welding current against grid fluctuation and arc length change to get optimal results.

Features and benefits:

- Perfect external static characteristic and dynamic characteristic
- Passive power factor correction, high power factor
- User friendly interface, easy operation
- Precise control and regulation, multi-purpose and convenient operation
- Store 30 sets of user-defined parameters to save operator's time
- Easy arc starting, HF or scratch ignition is available for TIG process
- Multiple security functions
- Fan-on-demand cooling system operates when needed to extend the service life of fan
- Multiple output waveforms, suitable for various aluminium alloys welding
- Remote controller or foot pedal is optional

## 1-2 Functional principle

This series of power sources adopt IGBT soft switch inverter technology to improve the dynamic response rate and make the machines with small size and light weight. The control circuit's closed-loop control makes the power source enjoy strong ability against power grid fluctuation and perfect welding performance. The schematic diagram is as shown in Fig. 1-2-1:

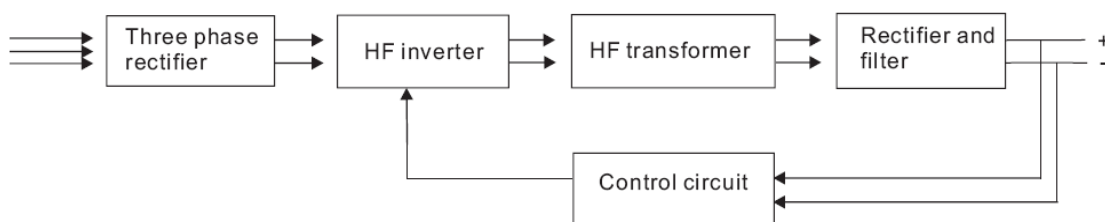

Fig. 1-2-1: Schematic diagram

## 1-3 Output characteristics

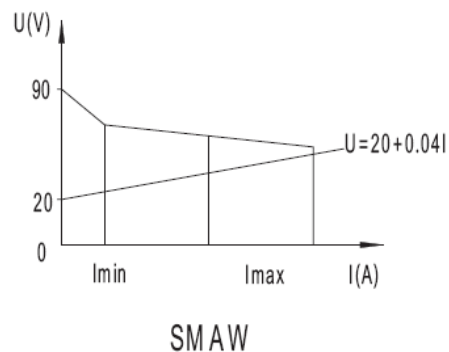
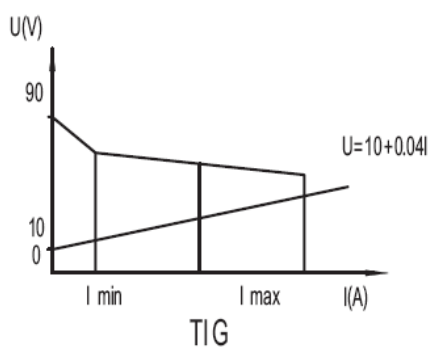





Fig. 1-3-1: Output characteristics

## 1-4 Duty cycle

Duty cycle is percentage of 10 minutes that a machine can weld at rated load without overheating. If overheats, thermostat(s) will open, output stops. Wait for fifteen minutes for the machine to cool down. Reduce amperage or duty cycle before welding.

 **NOTE!** Exceeding duty cycle can damage the machine and greatly reduce its lifespan.

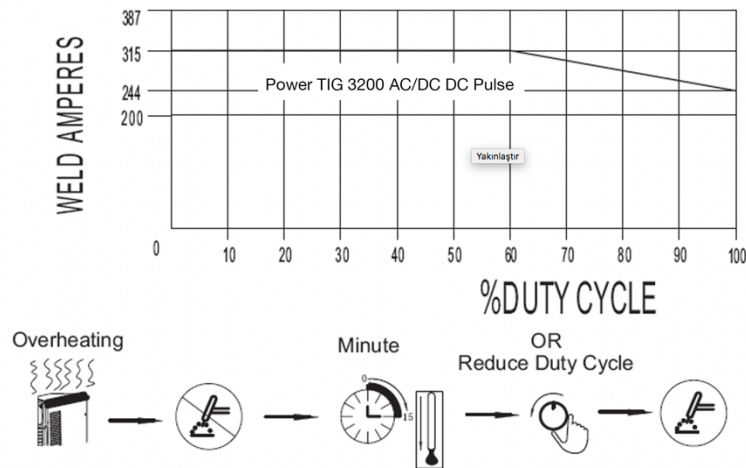

Fig. 1-4-1: Duty cycle

## 1-5 Applications

This series of machines have many welding processes and can weld most of the metal materials, including carbon steel, stainless steel, copper, titanium, aluminium and Al-Mg alloy etc.

Recommended areas of use are as follows:

- Boiler and container manufacture
- Aerospace industry
- Chemical structure and engineering
- Electric power construction
- Shipbuilding and offshore engineering
- Automobile
- Vehicle manufacture
- Mechanical industry
- Others

## 1-6 Warning label

The warning label is affixed onto the top of the power source, and it must not be removed or painted over.

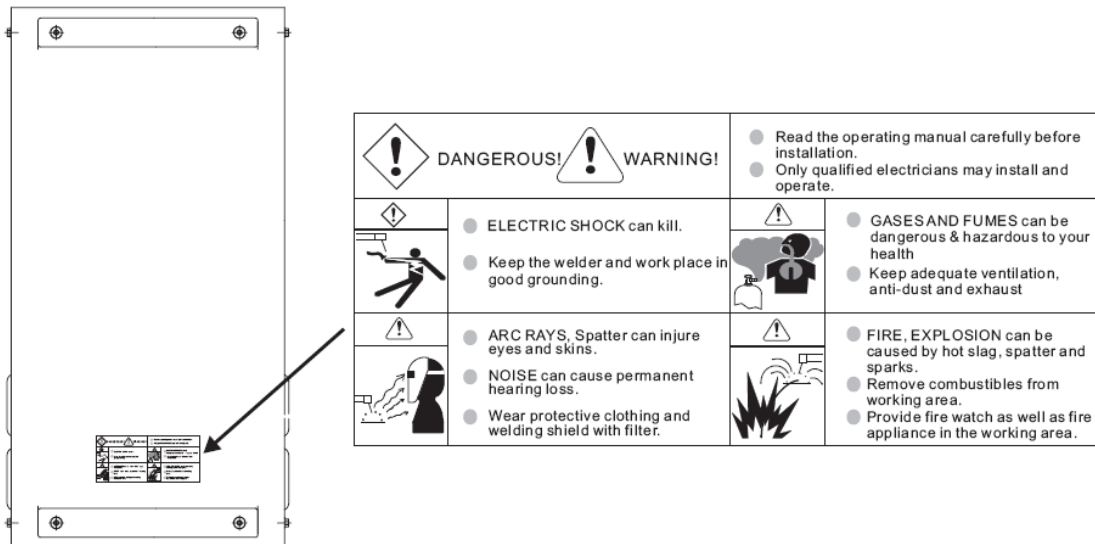

Fig. 1-6-1: Warning label

## 2- VERSIONS BRIEFS

Professional welding of special materials requires special welding parameters. Different models of the power sources are matched to different weldings.

- **Power TIG 3200 AC/DC DC Pulse**

This fully digitized power sources have logically arranged control panel for convenient operation, which can perform SMAW, DC TIG, DC Pulse TIG, AC TIG and AC Pulse TIG.

- **Power TIG 3200 AC/DC DC Pulse**

Besides the functions of **Power TIG 3200 AC/DC DC Pulse**, the digital remote control function can be realized.

- **Power TIG 3200 AC/DC DC Pulse**

The fully digitized power sources have more precise control. Besides functions of **Power TIG 3200 AC/DC DC Pulse**, multiple current output waveforms are available for AC welding. They are capable of storing 30 sets of user-defined parameters and realizing synchronous mutual arc welding.

### 3- BEFORE COMMISSIONING

 **Warning!** Operating the equipment incorrectly can cause serious injury and damage. Do not use the machine until you have read "Safety rules".

#### 3-1 Utilization for intended purpose only

The power source may only be used for SMAW and TIG welding. Utilization for any other purposes, or in any other manner, shall be deemed to be "not in accordance with the intended purpose". The manufacturer shall not be liable for any damage resulting from such improper use.

Please perform the operation, inspection and maintenance in accordance with all the instructions in this manual.

#### 3-2 Machines set-up regulations

According to test, protection degree of this power source is IP21S (optional IP23S). However, the internal key components must be protected from direct soaking.

 **Warning!** A machine that topples over or falls can easily cause harm to people. Please firmly install the machine on a stable place.

The venting duct is very important for safety protections. When choosing the machine location, make sure it is possible for the cooling air to freely enter and exit through the louvers on the front and back of machine. Any electro conductive metallic dust like drillings must not be allowed to get sucked into the machine.

#### 3-3 Power source connection

- The power source is designed to run on the voltage given on the nameplate.
- The mains cables and plugs must be mounted in accordance with the relevant technical standards.
- The power supply sockets that come with power source are designed to use strictly according to the marked voltages.

 **Note!** Incorrect installations can lead to protection fails or partial fails. The fuse of mains plug and socket must be suitable for local power supply.

#### 3-4 Welding cables instruction

In AC TIG welding, please pay attention to the followings.

- The welding cables should be kept as short as possible
- If extended cable is used, please do as shown in Fig. 3-4-1

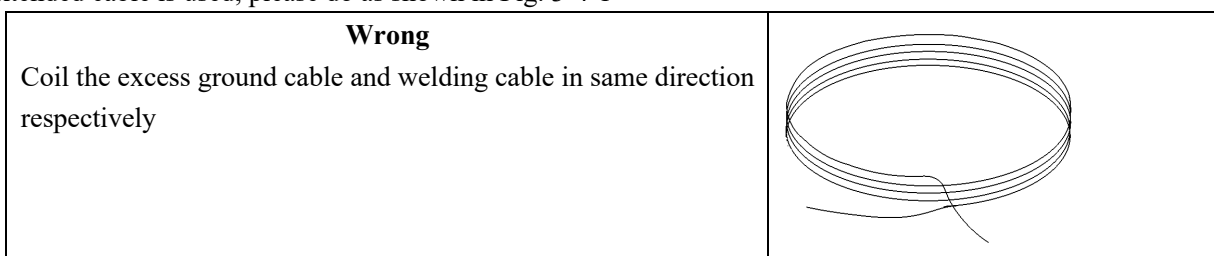

|   |  |
|---|--|
| <p style="text-align: center;"><b>Correct</b></p> <p>Straighten the ground cable and welding cable and make them close to each other</p> <p>Bundle the ground cable and welding cable together, running the wires close to the ground</p>   |   |
| <p style="text-align: center;"><b>Correct</b></p> <p>When the excess cables can only be used by rolling up, coil the cables to two windings in reverse directions and overlap them.</p> <p>The number of turns for A is same as the number for B.</p> <p>Handle the welding cable and ground cable according to above-mentioned method.</p> |  |

Fig. 3-4-1: Welding cables instruction

## 4- Power TIG 3200 AC/DC DC Pulse

### 4-1 System components

This series of machines can be equipped with many different accessories and can be used in various special sites with different configurations (as shown in Fig. 4-1-1).

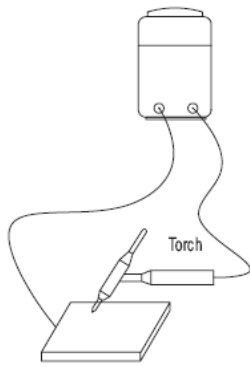
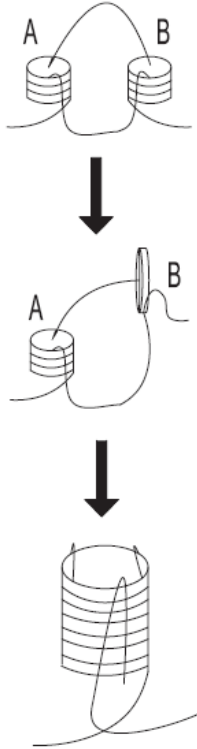
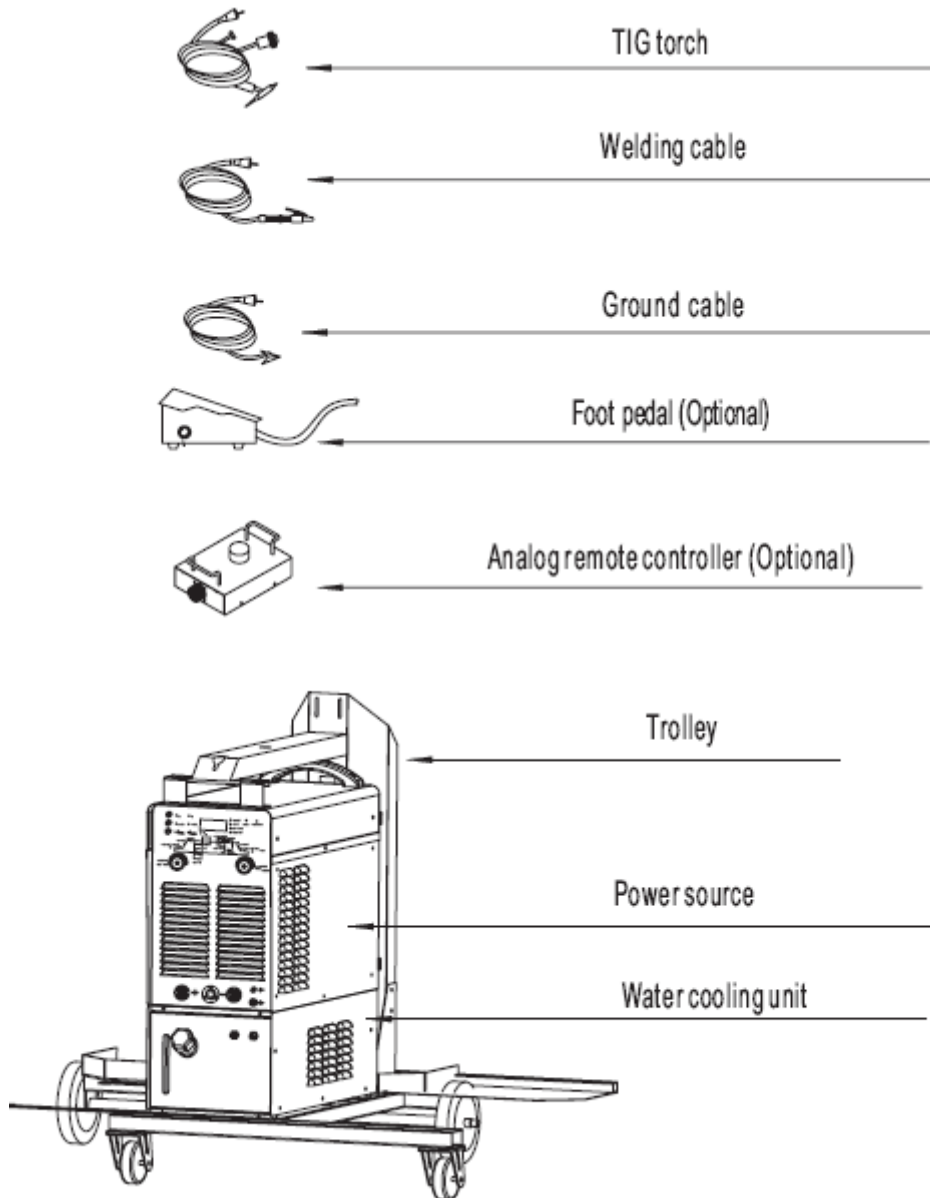

Fig. 4-1-1: System components

### 4-2 Basic equipments for welding

Depending on the selected welding processes, the power sources must be equipped with necessary accessories for welding. The following are the accessories lists for different welding processes.

- TIG welding
  - Power source
  - Ground cable

- TIG torch
- Gas regulator, gas hose, gas cylinder (to supply the machine with shielding gas)
- Welding wire
- SMAW welding
  - Power source
  - Ground cable
  - Electrode holder
  - Electrode

### 4-3 Control panel

The functions on the control panels are all arranged in a logical way, and the welding waveforms make the operation easier and convenient. The parameters are easy to select and adjust by the button or knob (Fig. 4-3-1).

**Note!** Some of the parameters in this manual may be different from that of your machines. Or some symbols may be not the same with that on your machines' front panel. But the working modes are the same.

**Warning!** Operating the equipment incorrectly can cause serious injury and damage. Do not use the functions described here until you have read and completely understood this operating manual.

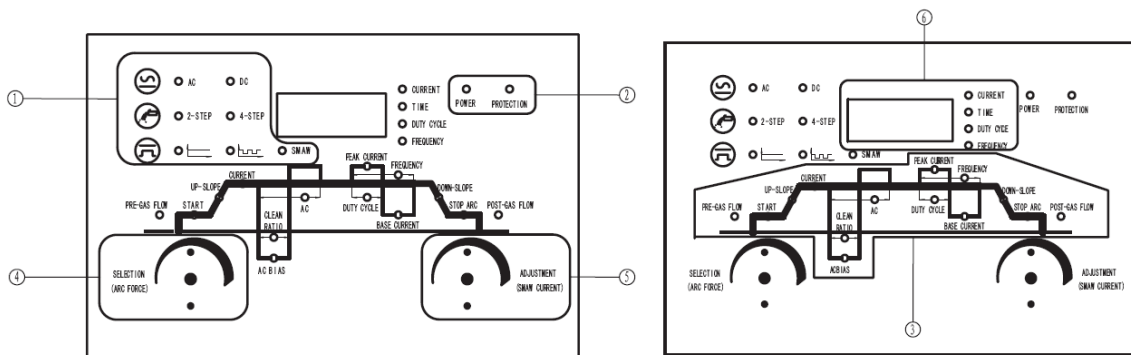
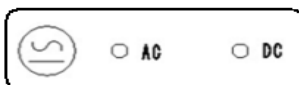
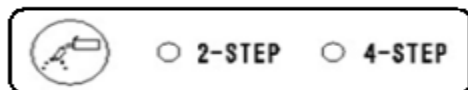

Fig. 4-3-1: Control panel

①



Press this button to switch between AC TIG and DC TIG, the indicator will lights up accordingly.



Press this button to switch between 2-step and 4-step operation mode, the indicator will lights up accordingly.

## Torch operation modes:

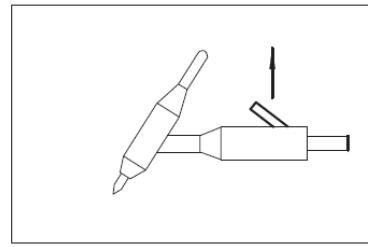
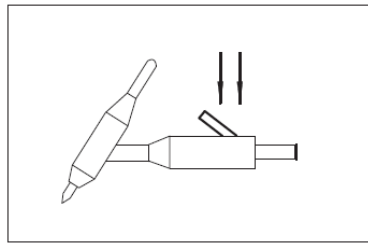
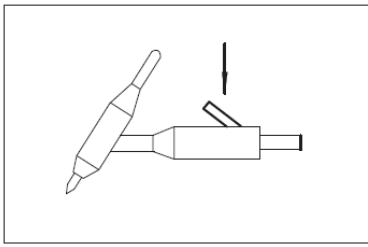

Fig. 4-3-2: Press torch trigger

Fig. 4-3-3: Hold torch trigger

Fig. 4-3-4: Release torch trigger

### 2-step operation mode (Fig. 4-3-5):

a. Press and hold torch trigger to start welding.

- Open solenoid valve, shielding gas will flow out to expel air from torch hose (pre-gas time depends on the hose length). Then, HF ignition device works and starts arc.
- Output current continuously increases from initial current to welding current.

b. Release torch trigger to stop welding.

- Release torch trigger, welding current will continuously decrease at a certain rate and time until it reaches to zero.
- The solenoid valve will continue to operate for a period of time (post-gas time), allowing the shield gas to protect tungsten electrode and molten pool. Then the solenoid valve stops working, gas stops and welding finishes.

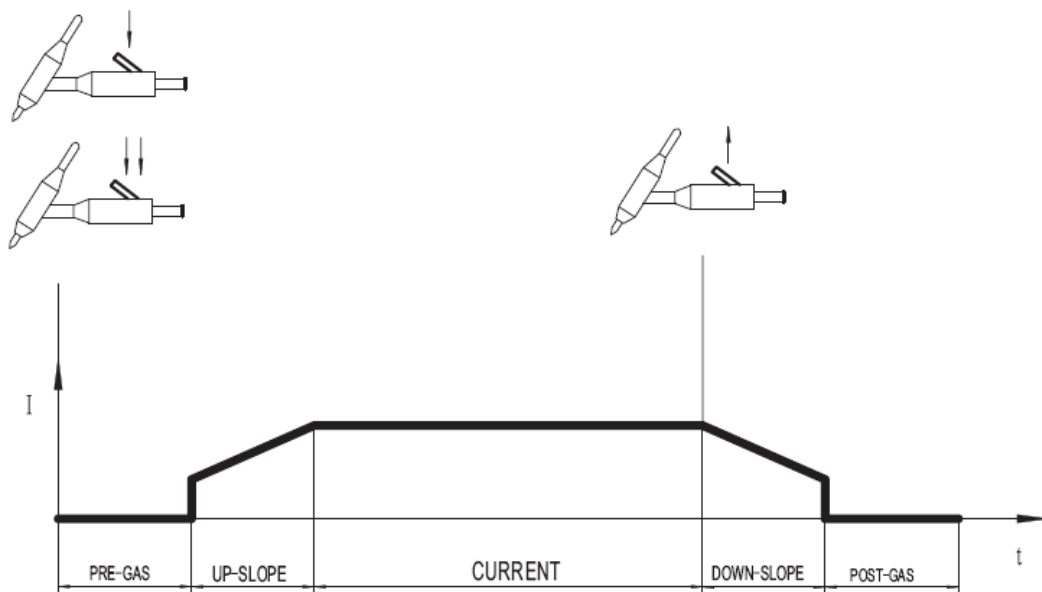

Fig. 4-3-5: 2-step Operation Mode

### 4-step operation mode (Fig. 4-3-6):

a. Press and hold torch trigger to start welding.

- Open solenoid valve, shielding gas will flow out to expel air from torch hose (pre-gas time depends on the hose length). Then, HF ignition device works and starts arc.
- Output current starts at initial current and time of initial current output depends on the time that torch trigger is pressed and held.

b. Release torch trigger.

- Output current increases from initial current to welding current, and the time is called up slope time.
- If the initial current is not required, the torch trigger need not to be held. Quickly press torch trigger to start arc, then quickly release it and output current will increase to welding current.

c. Press and hold torch trigger again when the welding completes.

- Welding current will continuously decrease at a certain rate until it reaches to crater-filler current and the time is called downslope time.
- Time of crater-filler current depends on the time that the torch trigger is pressed and held again.

d. Release torch trigger.

- The output current is continuously lowered to zero and arc blowout. The solenoid valve will continue to work for the selected period of time (post-gas time), allowing the shielding gas to protect tungsten electrode and molten pool. Then the solenoid valve stops running, gas stops and welding completes.

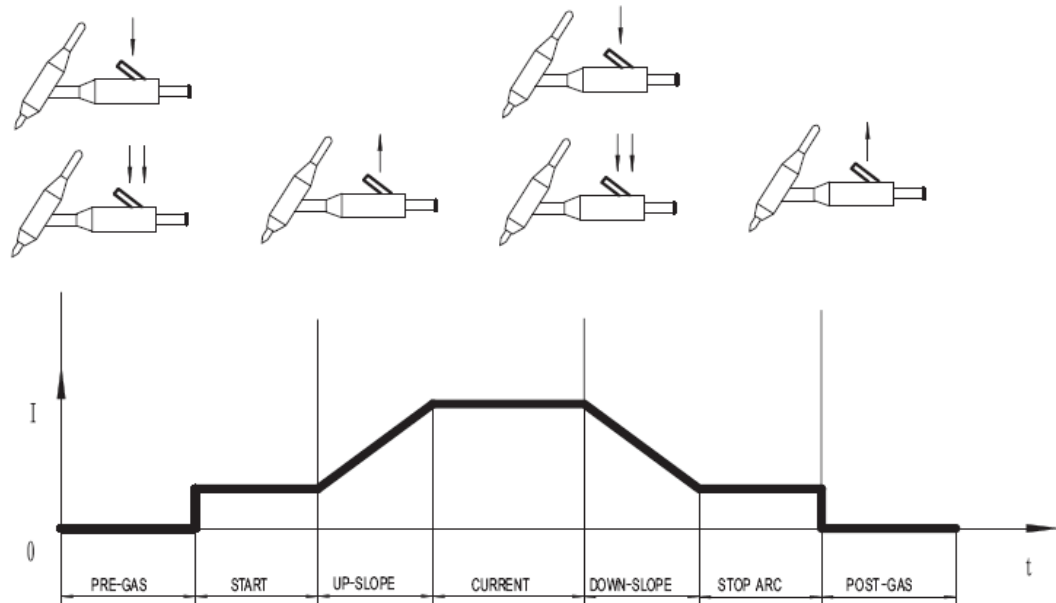

Fig. 4-3-6: 4-step operation mode



Press this button to switch between TIG, Pulse TIG and SMAW, the indicator will light up accordingly.

**Note: Only DC current is output if SMAW has been selected.**

②

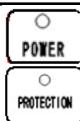
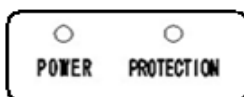

Lights up if the machine is switch on; lights off if there's some problem with power supply.

Lights off if the machine operates properly. Lights up if the power source overheats or over-voltage, the relevant error code will appear on the displayer and machine stops running.

**Error codes are illustrated as follows:**



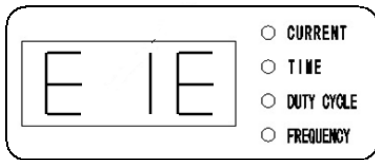

&

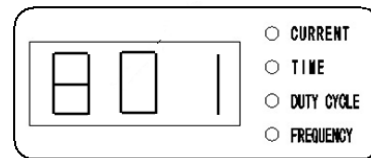

Cause: Over-voltage protection

Remedy: Contact after-sale service

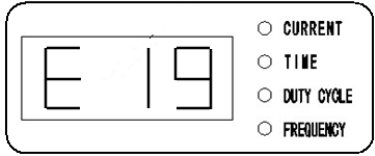

&

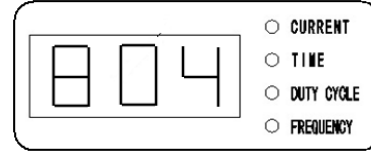

Cause: Overheat protection

Remedy: Shut down the machine and cool down by fan running for 15 minutes

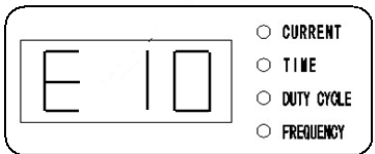

&

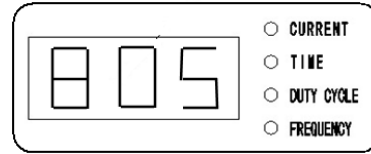

Cause: The torch trigger is pressed for a long time without welding.

Remedy: Release torch trigger, if the error keeps occurring, check and repair the torch or foot pedal.

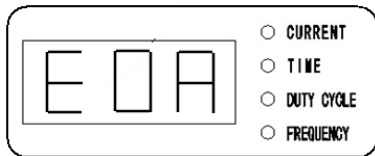

&

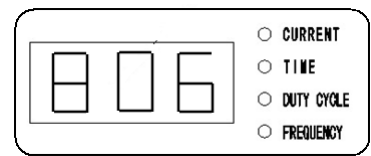

Cause: Water shortage protection

Remedy: Check the water-cooling unit, water circulating switch and signal wire. When using gas-cooling torch, check the machine settings.

### Water cooling/Gas cooling shift

**Important!** The machine setting should be changed depending on gas-cooled or water-cooled torch. Otherwise, the error codes will occur (the factory setting is water-cooling).

- When using water-cooling torch, press and hold the parameter setting knob and adjustment knob at same time for 3 seconds, the machine will display "E0A/806" code and set to water-cooling state. Start the water-cooling unit and the "E0A/806" code will disappear automatically as soon as the water-cooling unit operates properly (Fig. 4-3-7).

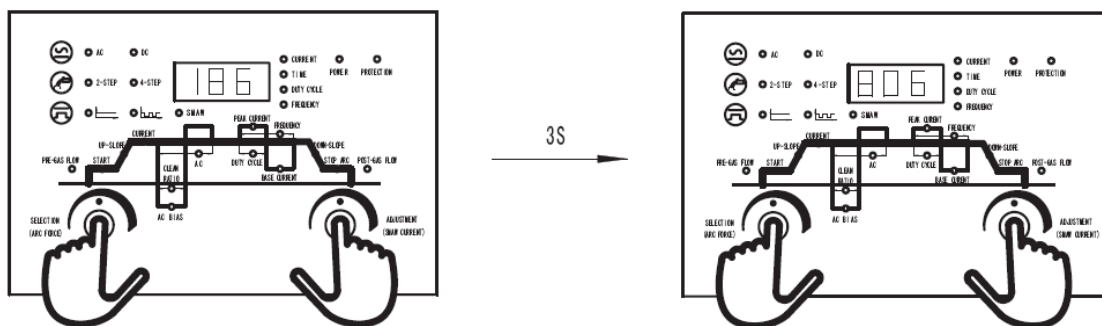

Fig. 4-3-7: Set to water-cooling state

- When using gas-cooled torch, press and hold the parameter setting knob and adjustment knob at same time for 3 seconds, the "E0A/806" code disappears and the machine is set to gas-cooling state. When using gas-cooled torch, welding machine do not show water shortage protection. (Fig. 4-3-8).

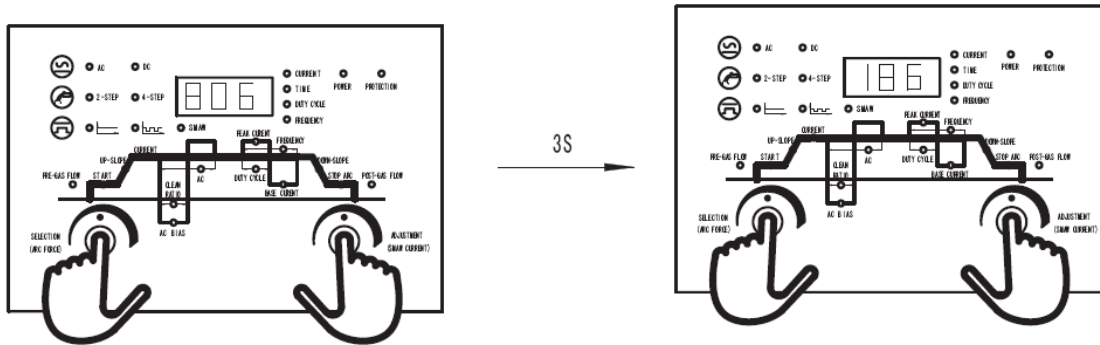
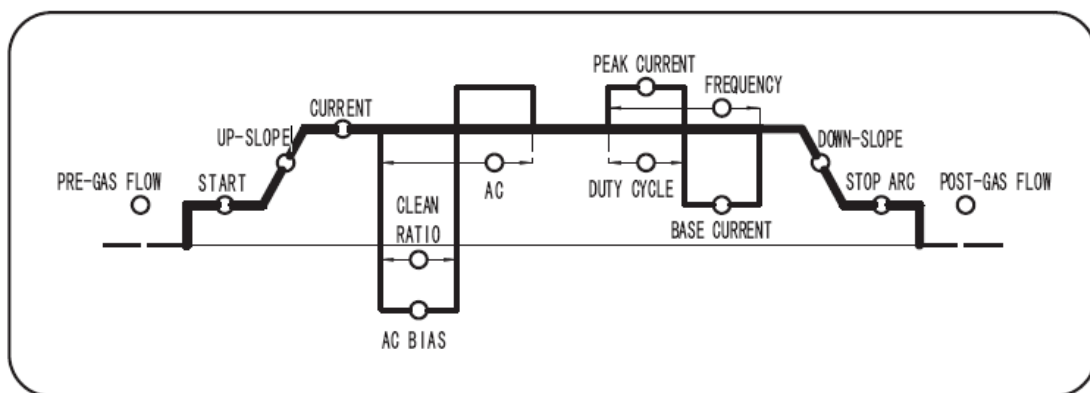

Fig. 4-3-8: Set to Gas-Cooling State

③



In TIG welding, this series power sources can output multiple waveforms and control them precisely. The simple waveform graph on control panel makes the operation easier. Detailed introduction of waveforms as follows:

● Waveform and parameter in DC constant current (Fig. 4-3-9)

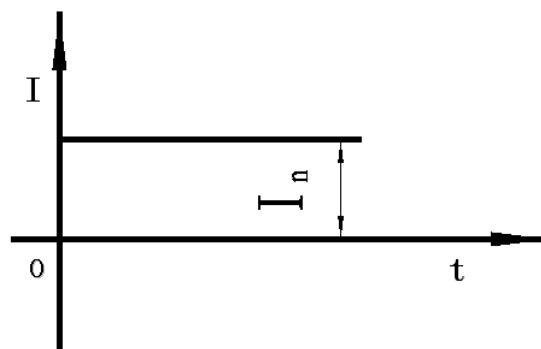

Fig. 4-3-9: Waveform and parameter in DC constant current

$I_n$  – to heat welding wire and work piece, and form a molten pool.

● Waveform and parameter in AC constant current (Fig. 4-3-10)

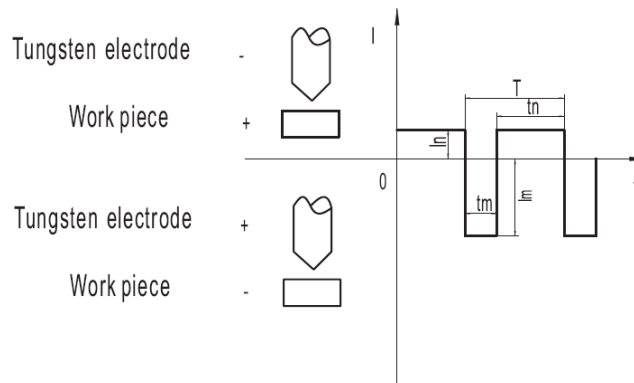

Fig. 4-3-10: Waveform and parameter in AC constant current

**$I_n$ –Positive half-wave current.** To heat welding wire and work piece, and form a molten pool, thus also known as welding current.

**$t_n$ –Positive half-wave time**

**$I_m$ –Reverse half-wave current.** Used for cleaning the oxide film on aluminum, magnesium and its alloy, thus also known as clean current.

**Clean current - TIG welding with DCRP (direct current reverse polarity) produces good cleaning action as the argon ions flowing towards the work piece strike with sufficient force to break up oxides on the surface of aluminum and magnesium. This is called "cleaning action", and the clean current is able to produce "cleaning action".**

**$t_m$ –Reverse half-wave time,** also known as clean time.

**T–Cycle**  $T = t_n + t_m$

**f–AC frequency**  $f = 1/T$

**$K_t$ –Clean ratio**  $K_t = (t_m/T - 0.5) \times 100\%$  Refers to the relative proportions of clean time in a single cycle.

**Important!** When the clean time is at half cycle, it is the zero point, that is  $t_m/T = 0.5$ ,  $K_t = 0\%$ ;  $t_m/T = 0.3$ ,  $K_t = -20\%$ , and so forth.

**$K_i$ –AC bias**  $K_i = (I_m/I_n - 1) \times 100\%$  Refers to the relative proportions of clean current and welding current.

**Important!** When the clean current is equal to welding current, it is the zero point of this parameter, that is  $I_m/I_n = 1$ ,  $K_i = 0\%$ ;  $I_m/I_n = 1.1$ ,  $K_i = 10\%$ .

● The waveform and parameter in DC Pulse and AC Pulse (Fig. 4-3-11 & Fig. 4-3-12)

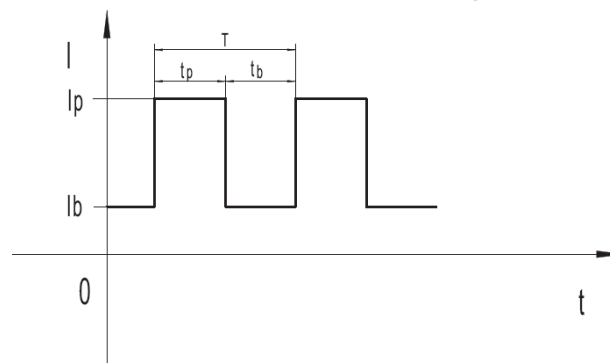

Fig. 4-3-11: The Waveform and parameter in DC Pulse

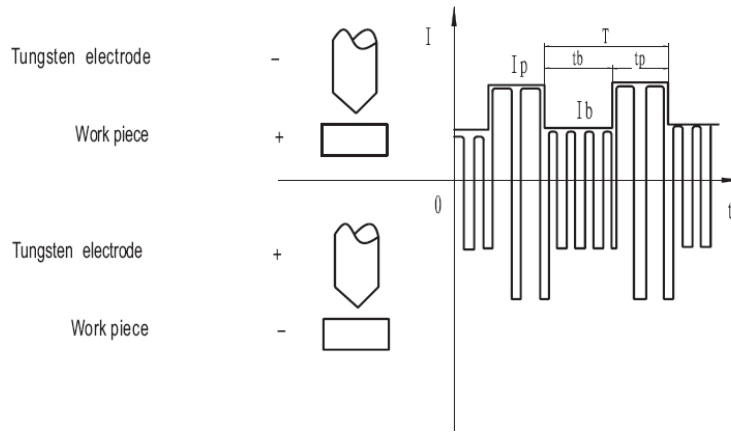

Fig. 4-3-12: The waveform and parameter in AC Pulse

**$I_p$ –Peak current.** Supply thermal input for welding wire and work piece to form a molten pool.

**$t_p$ –Peak current time.**

**$I_b$ –Base current.** Maintains the arc burning and makes the molten pool cooled.



**$t_b$ –Base current time.**

**T–Cycle**  $T = t_p + t_b$

**f–Pulse frequency**  $f = 1/T$

**$\beta$ –Duty cycle**  $\beta = t_p/T \times 100\%$

**Parameters on control panel ③:**

|   |
|---|
| <p>PRE-GAS TIME<br/>–Time of gas flow before welding<br/>Unit: S<br/>Range: 0.1~15<br/>Factory setting: 0.2</p>   |
| <p>START<br/>–The initial current at the arc starting<br/>Unit: A<br/>Range: 10~160 (<b>Power TIG 3200 AC/DC DC Pulse</b>)<br/>Factory setting: 50</p>  |
| <p>UP-SLOPE TIME<br/>–Time of starting current is increased until it reaches welding current.<br/>Unit: S<br/>Range: 0.1~10<br/>Factory setting: 0.2</p>  |
| <p>CURRENT<br/>–The welding current in  and  mode, producing uniform thermal input into base metal.<br/>Unit: A<br/>Range: 5~315(<b>Power TIG 3200 AC/DC DC Pulse</b>)<br/>Factory setting: 100</p> |

### CLEAN RATIO

–Time proportions of clean current output in AC mode.

Unit: %

Range: -40~+40

Factory setting: 0

**In AC TIG welding, the clean ratio can be adjusted in order to alter the width of oxide surface and the size of penetration for excellent welding result. The adjustment effect is as shown in Fig. 4-3-13:**





|                              |   |   |
|------------------------------|---|---|
| <b>Clean ratio</b>           | reduce<br> | increase<br> |
| <b>Weld effect</b>           |            |              |
| <b>Waveform</b>              |            |              |
| <b>Electrode consumption</b> | <b>Less</b>   | <b>More</b>   |

Fig. 4-3-13: Clean ratio adjustment effect

### AC BIAS

–In AC mode, the relative proportions of clean current and welding current.

Unit: %

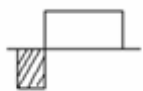
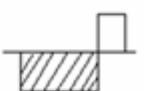
Range: -50~+30

Factory setting: 0

Change this parameter to adjust the clean current, achieving the excellent clean result, performance, as shown in Fig. 4-3-14.





|                              |   |   |
|------------------------------|---|---|
| <b>AC bias</b>               | reduce<br> | increase<br> |
| <b>Clean effect</b>          | <b>Poor</b>   | <b>Good</b>   |
| <b>Waveform</b>              |            |              |
| <b>Electrode consumption</b> | <b>Less</b>   | <b>More</b>   |

Fig. 4-3-14: AC bias adjustment effect

**Important!** In the same clean effect, decreasing clean ratio and increasing AC bias ratio will get deeper penetration, higher productivity and longer lifetime of tungsten electrode.

### AC

–The frequency of welding current in AC mode.

Unit: Hz

Range: 20~200 (**Power TIG 3200 AC/DC DC Pulse**)

Factory setting: 50

### PEAK CURRENT

–The peak current in DC pulse or AC pulse mode.

Unit: A

Range: 5~315(**Power TIG 3200 AC/DC DC Pulse**)

Factory setting: 100

#### DUTY CYCLE

–The time proportion of peak current in single cycle under DC pulse or AC pulse mode, can be used for controlling penetration in all-position or thin sheet welding.

Unit: %

Range: 1~100

Factory setting: 30

#### FREQUENCY

–The frequency of welding current in DC pulse or AC pulse mode.

Unit: Hz

Range: 0.2~20

Factory setting: 4.0

#### BASE CURRENT

–The arc maintenance current in DC pulse or AC pulse mode.

Unit: A

Range: 5~315(**Power TIG 3200 AC/DC DC Pulse**)

Factory setting: 50

#### DOWN-SLOPE TIME

–Time of welding current is continuously lowered until it reaches final current.

Unit: S

Range: 0.1~15

Factory setting: 0.5

#### STOP ARC

–The current before arc blowout.

Unit: A

Range: 5~315(**Power TIG 3200 AC/DC DC Pulse**)

Factory setting: 50

#### POST-GAS TIME

–Time of gas flow after arc blowout.

Unit: S

Range: 0.1~60

Factory setting: 5.0

④

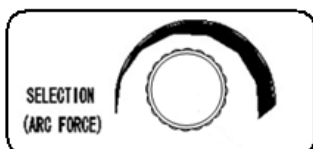

–In TIG welding process, it is used for selecting the parameters that are described in ③. Rotate clockwise to select parameter from left to right; rotate anticlockwise to select parameter from right to left.

–Adjust the arc force in SMAW welding process.



Unit: A

Range: 10~200

Factory setting: 50

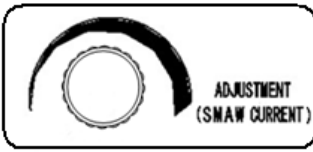
⑤



- In TIG welding process, it is used for adjusting the parameters that are described in ③. When a parameter is selected by , rotate  clockwise to increase the selected parameter; rotate  anticlockwise to decrease the selected parameter. Press this button and turn to left or right for quick adjustment;

- In SMAW welding process, it is used for adjusting welding current.

Unit: A

Range: 5~315(Power TIG 3200 AC/DC DC Pulse)

Factory setting: 100

⑥

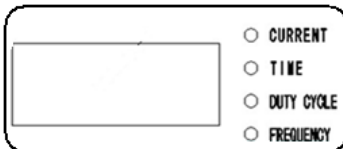

It is used for displaying the preset or actual parameter in ③, and the corresponding indicator will light up.

For example: if the preset current is 186A, the digital displayer is as shown in Fig. 4-3-15:



Fig. 4-3-15: Digital displayer

**Important!** Thanks to the microprocessor control, the following functions can be realized:

- All parameters that have been set can be automatically stored and will retain until the next time they are changed. This is true even if the power source is switched off and on again in the meantime.
- Press and hold the parameter selection knob and CC/Pulse/SMAW button at same time for 3 seconds to restore to factory setting (Fig. 4-3-16).

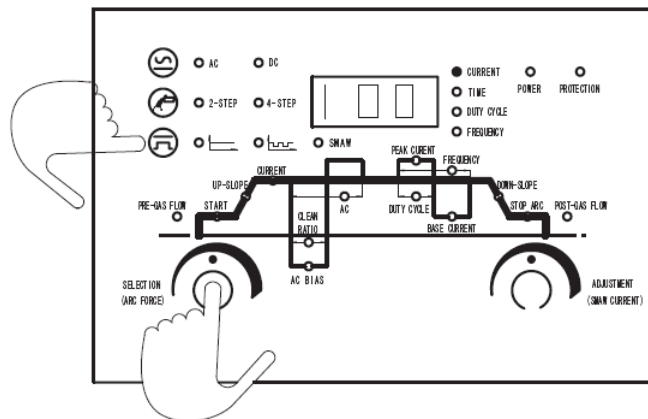

Fig. 4-3-16: Restore to factory setting

## 4-4 Interface

- Interface on front panel (Fig. 4-4-1):

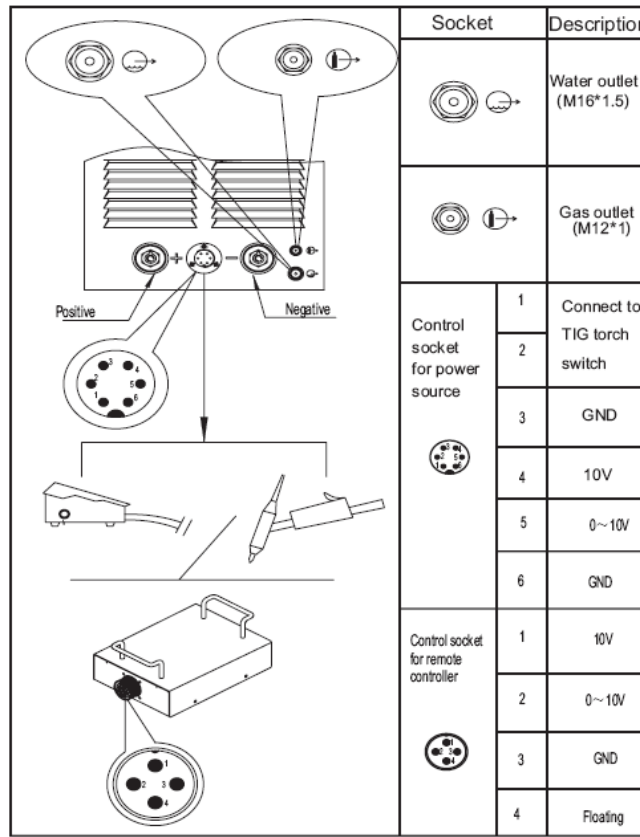

Fig. 4-4-1: Interface on front panel



● **Interface on rear panel (Fig. 4-4-2):**

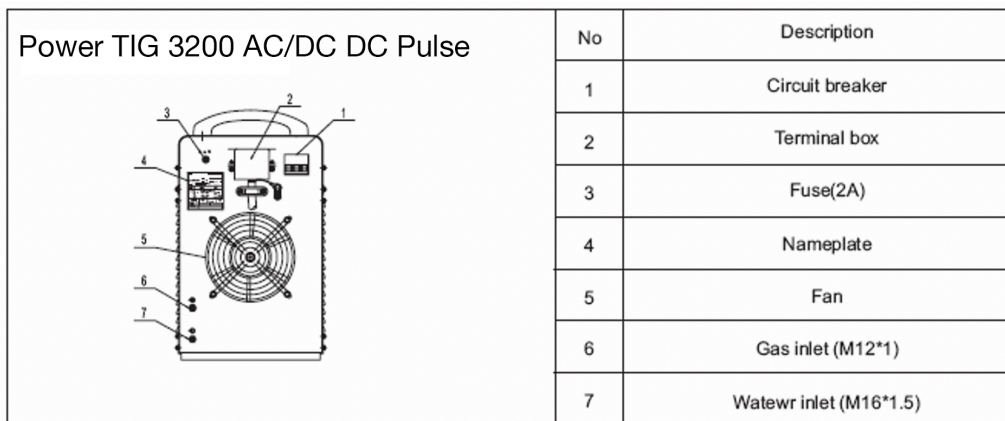

Fig. 4-4-2: Interface on rear panel

● **Output socket**

There are two types of output sockets: quick-plug type and compression joint. They must be matched with different cable plugs when use, as shown in Fig. 4-4-3.

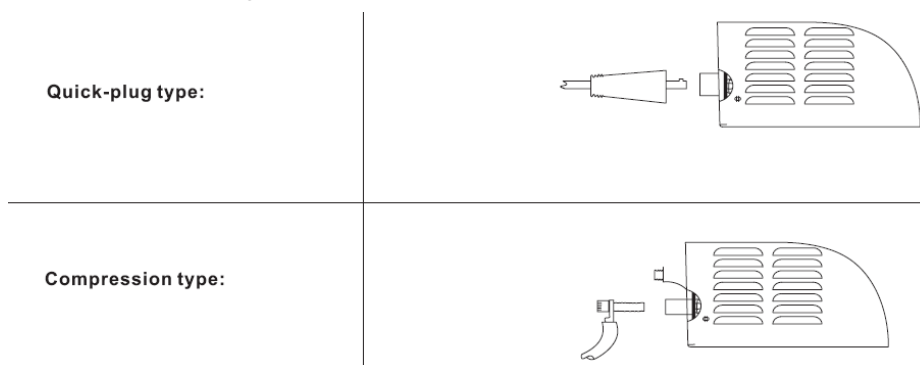

Fig. 4-4-3: Output socket

● **Foot pedal**

The foot pedal can be used for arc starting control and current regulation of this series of power sources. The machine will switch automatically to pedal control after the control plug is connected to the control cable socket of power source. When the pedal is stepped on, the machine begins to work at welding current in line with the degree of pedal being stepped. The upper limit value is controlled by the potentiometer on the pedal (Fig. 4-4-4).

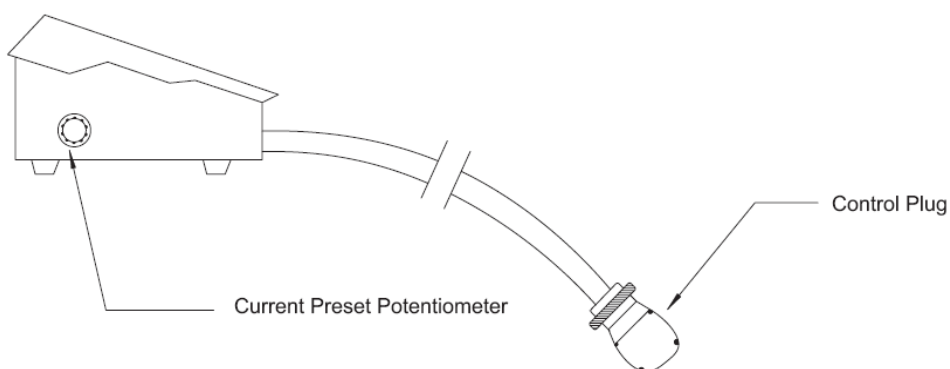

Fig. 4-4-4: Foot pedal

● **Analog remote controller**

The analog remote controller can be used for current regulation of this series power sources. The welding current is automatically controlled by remote controller as soon as the plug is connected to the control socket of power source (Fig. 4-4-5).

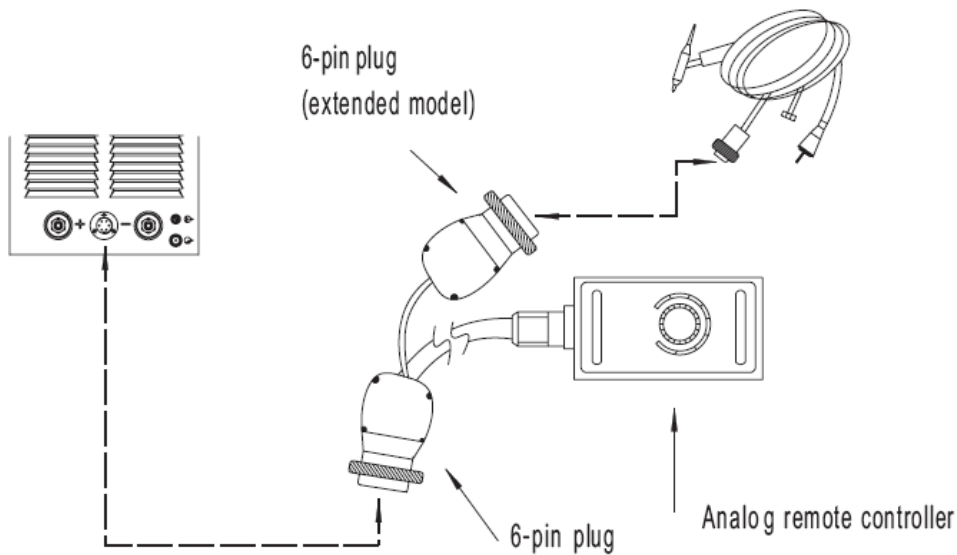

Fig. 4-4-5: Analog remote controller

### 4-5 Water-cooling system

The water-cooling unit is powered by the power source. The water-cooling unit is in operation when the power source is switch on. The interfaces are as shown in Table 4-5-1.

|   |    |                     |
|---|----|---------------------|
|   | NO | Description         |
| 1 | 1  | Water inlet (red)   |
| 2 | 2  | Water outlet (blue) |
| 3 | 3  | Water injection     |
| 4 | 4  | Water marks         |
| 5 | 5  | Nameplate           |
| 6 | 6  | Fan                 |

Table 4-5-1: Water-cooling system

**Notice!** Please check the coolant level and purity before using. Please take freeze-proofing measures when the temperature is too low.

### 4-6 Installation and operation

**Warning!** If the power source is switch on during installation, there is a high risk of very serious injury and damage. Only carry out work on the machine when you have read "Safety rule" and when

- the mains switch is off
- the machine is unplugged from the mains

#### ● Input power supply cable installation

Please note the size of fuse and circuit breaker in the table below are for reference only.

**Single voltage:**

| Model                         |                     | 315                                   | 500 | 630 |
|-------------------------------|---------------------|---------------------------------------|-----|-----|
| Power supply                  |                     | Three phase AC380V/400V/415V, 50/60Hz |     |     |
| Min. capacity (KVA)           |                     | 14                                    | 27  | 45  |
| Input protection (A)          | Fuse                | 20                                    | 40  | 60  |
|                               | Circuit breaker     | 40                                    | 60  | 100 |
| Cable size (mm <sup>2</sup> ) | Input cable         | 4                                     | 6   | 10  |
|                               | Output cable        | 35                                    | 50  | 70  |
|                               | Protective GND wire | 4                                     | 6   | 10  |

Table 4-6-1: Input power supply cable installation -single voltage

**Multi voltage:**

| Model                         |                     | 315                            | 500 | 630 |
|-------------------------------|---------------------|--------------------------------|-----|-----|
| Power supply                  |                     | Three phase, AC 220/440V, 60Hz |     |     |
| Min. capacity (KVA)           |                     | 14                             | 27  | 45  |
| Input protection (A)          | Fuse                | 40                             | 40  | 60  |
|                               | Circuit breaker     | 60                             | 60  | 100 |
| Cable size (mm <sup>2</sup> ) | Input cable         | 6                              | 6   | 10  |
|                               | Output cable        | 50                             | 50  | 70  |
|                               | Protective GND wire | 6                              | 6   | 10  |

Table 4-6-2: Input power supply cable installation - multi voltage

- The connection between input cable and distributor box (Fig. 4-6-1):



**Warning!** - Never perform hot-line work!

- Electric connection should be done by professional electrician!
- Two machines should not be connected to the same one circuit breaker!
- Check the input voltage, circuit breaker, input cable in accordance with Table 4-6-1 and Table

4-6-2.

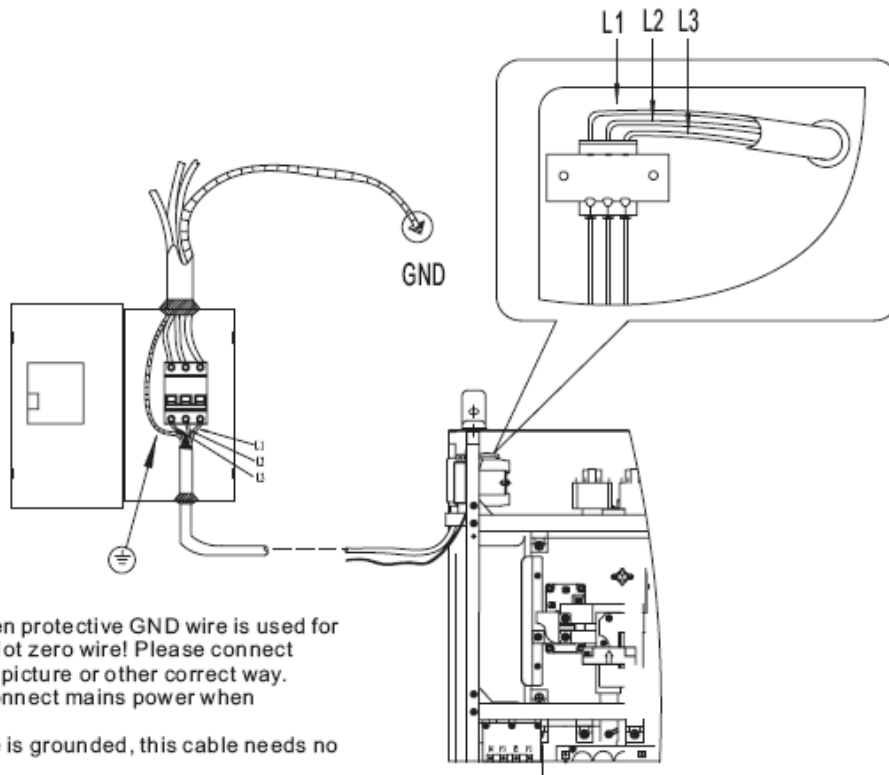

Fig. 4-6-1: Connection between input cable and distributor box

● **Shielding gas regulator installation**

**Warning!** The inert gas can be hazardous to your health. Work in a place only if it is well ventilated. Please do not use the shielding-gas cylinder until you have completely read and followed all the instructions about shielding-gas cylinder and accessories.

1. If the water-cooling unit is integrated with power source, place the shielding-gas cylinder on the trolley, and secure it by fixing the cylinder strap around a point in the top third of cylinder –but never around the neck of cylinder. If the water-cooling unit is separated from power source, place the shielding-gas cylinder on the solid, level surface or use cylinder bracket to prevent from toppling over.
2. Take the protective cap off the shielding-gas cylinder.
3. Briefly open the shielding-gas cylinder valve anticlockwise to blow off any dust and dirt.
4. Check the tightness of pressure regulator.
5. Screw the pressure regulator onto the gas cylinder and tighten it.
6. Connect the shielding-gas connector to the pressure regulator.

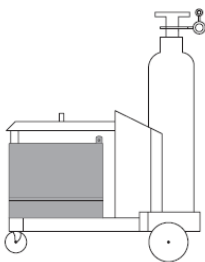

Fig. 4-6-2: Shielding gas regulator installation

● **TIG welding**

**Warning!** Operating the machine incorrectly can cause serious injury and damage. Do not use the machine until you have read the following

- Safety rules
- Before putting the machine into service

**Warning!** If the machine is plugged into the mains supply and the mains switch is in "O" position during preparation, there is a high risk of very serious injury and damage. Only carry out preparation when the machine is unplugged from the mains and the mains switch is off.

• **The connection and operation for gas-cooling TIG welding (Fig. 4-6-3)**

1. Plug the ground cable into the output socket (+) and fasten it
2. Connect the other end of ground cable to the work piece
3. Plug the six-pin plug of torch into the control socket of power source
4. Plug the quick plug on the end of torch into the output socket (-) and fasten it
5. Plug the gas hose plug on the end of torch into the gas outlet of power source and screw it
6. Screw the gas regulator onto the gas cylinder and tighten it
7. Connect the gas hose to the outlet of pressure regulator and fasten it with hose clamp; connect the other end of the gas hose to the inlet on rear panel of power source and fasten it with hose clamp
8. Make good connection between the input cable and distributor box, and put the circuit breaker on open position
9. Switch on the power source

**Warning!** An electric shock can be fatal. The torch is power on as soon as pressing the torch trigger. Make sure that the torch does not touch any person or conductor or grounded parts (e.g. hanger).

10. Press  button to select welding process:

- AC - DC

11. Press  button to select torch operation mode:



- 2-STEP - 4-STEP

12. Press  button to select TIG welding process:

- CC TIG - Pulse TIG

**Note!** "SMAW" welding process should not be selected when the TIG process has been selected. The "SMAW" is activated if selecting "SMAW".

13. Turn  knob to select TIG welding parameter

14. Turn  knob to adjust the welding parameter which is selected by 

15. Open the gas regulator valve

16. Press the torch trigger and set proper gas flow rate on the gas regulator, then release the trigger

17. Press torch trigger again to start welding

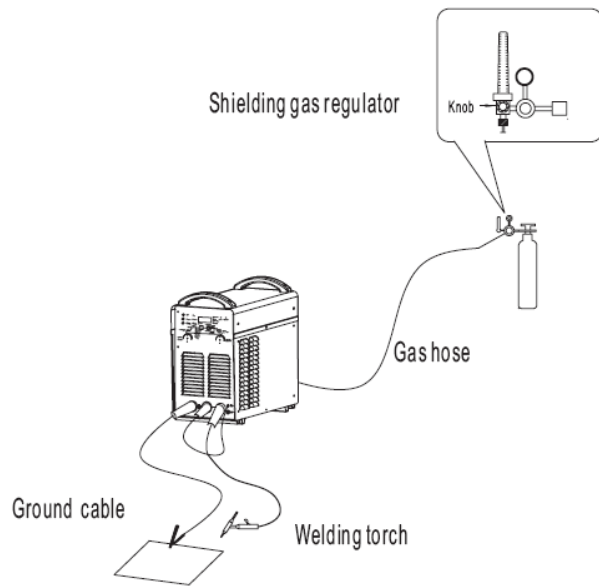



Fig. 4-6-3: Connection and operation for gas-cooling TIG welding

**Important!** In order to obtain optimal welding results in TIG welding, sometimes it is necessary to set the tungsten electrode diameter. Press and hold the parameter selection knob and 2-step/4-step button at same time for 3 seconds to enter the tungsten electrode diameter selection menu, then turn  knob to select the desired tungsten electrode diameter (Range: 0.8~6.0 mm, factory setting: 2.0 mm), as shown in Fig. 4-6-4.

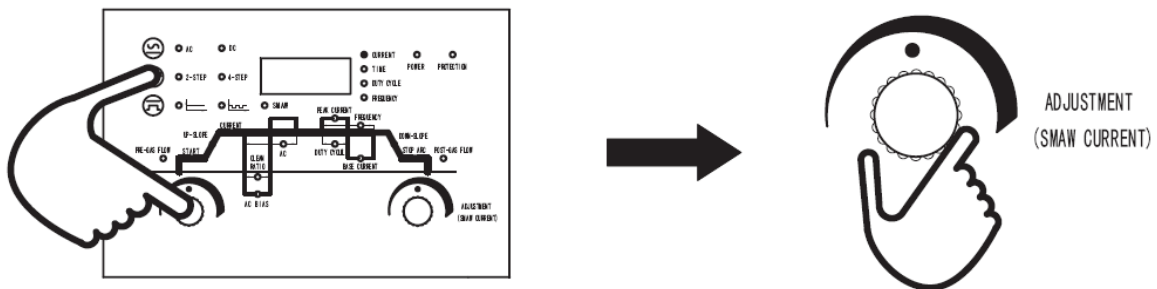



Fig. 4-6-4: Set the tungsten electrode diameter

● **The connection and operation for water-cooling TIG welding**

TIG welding with water-cooled torch also requires water-cooling unit. There are two types of water-cooled TIG power sources:

- The water-cooling unit is separated from power source
- The water-cooling unit is integrated with power source

For water-cooling unit is separated from power source, the connection is as shown in Fig. 4-6-5:

 **Note!** For TIG welding with the water-cooling unit that is separated from power source, you need to connect and operate the water-cooling unit, then switch the power source from gas-cooling to water-cooling state (see the state setting in "4-3 Control panel" for details ), all other connections are same as described in "The connection and operation for gas-cooling TIG welding". The connection and operation for water-cooling unit are as follows:

1. Connect the water hose to the water inlet  on rear panel of power source, and fasten it with hose clamp;

connect the other end of water hose to the water outlet (blue)  of water-cooling unit.

2. Connect the water inlet hose at end of torch to the water outlet  on front panel of power source and fasten it.

3. Connect another water hose to the water return of torch and fasten it with hose clamp; connect the other end of water hose to the water return (red)  of water-cooling unit.

4. Plug the power plug of water-cooling unit into the power supply socket.

5. Switch on the water-cooling unit.

 **Note!** If the coolant flow is insufficient, it may cause damage to the equipment. Check the coolant flow at regular intervals when welding - it must be able to see the coolant is flowing properly.

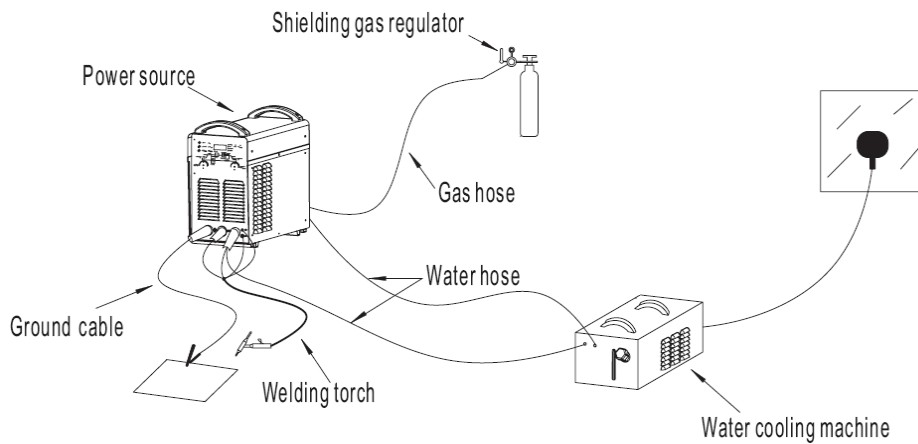





Fig. 4-6-5: Water-cooling unit connection

**For water-cooling unit is integrated with power source, the connection of water-cooling unit is as follows (Fig. 4-6-6):**

 **Note!** For TIG welding with the water-cooling unit is integrated with power source, you need to connect the water-cooling unit, then switch the power source from gas-cooling to water-cooling state (see the state setting in "4-3 Control panel" for details), all other connections are same as described in "The connection and operation for gas-cooling TIG welding".

1. Connect the water inlet hose at end of torch to the water outlet (blue)  on front panel of water-cooling unit and fasten it.

2. Connect the water hose to the water return of torch and fasten it with hose clamp; connect the other end of water hose to the water return (red)  of water-cooling unit.

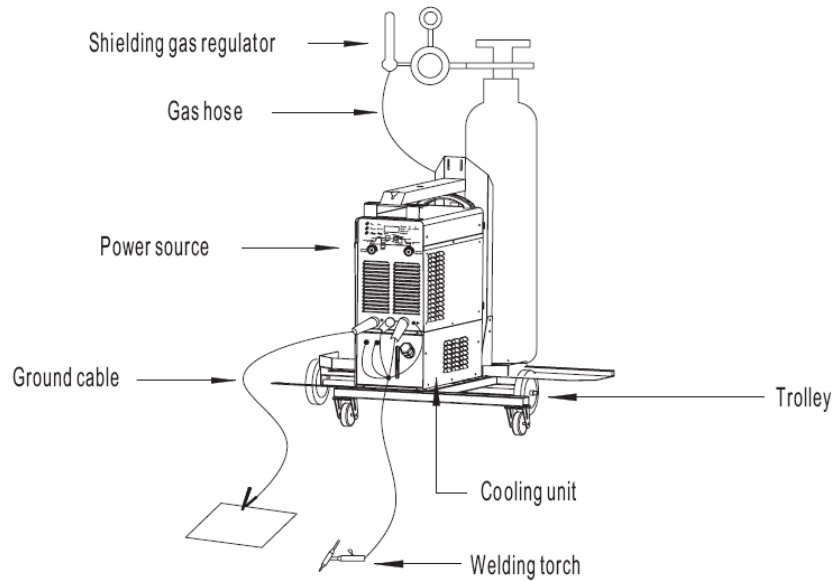





Fig. 4-6-6: Integrated with power source water-cooling unit connection

● **SMAW welding**

**Warning!** Operating the machine incorrectly can cause serious injury and damage. Do not use the machine until you have read the following:

- Safety rules
- Before putting the machine into service

**Warning!** If the machine is plugged into the mains supply and the mains switch is in "O" position during preparation, there is a high risk of very serious injury and damage. Only carry out preparation when the machine is unplugged from the mains and the mains switch is off.

1. Plug the ground cable into the output socket (-) and fasten it;
2. Connect the other end of ground cable to the work piece;
3. Plug the welding cable into the output socket (+) and fasten it;
4. When using wired remote controller, make connection in accordance with the relevant method;
5. Make good connection between the input cable and distributor box, and put the circuit breaker on open position;
6. Switch on the mains switch;
7. Press  button to select "SMAW";
8. Turn  knob to adjust the arc force in SMAW process;
9. Turn  knob to adjust the welding current in SMAW process;
10. Start welding (Fig. 4-6-7).



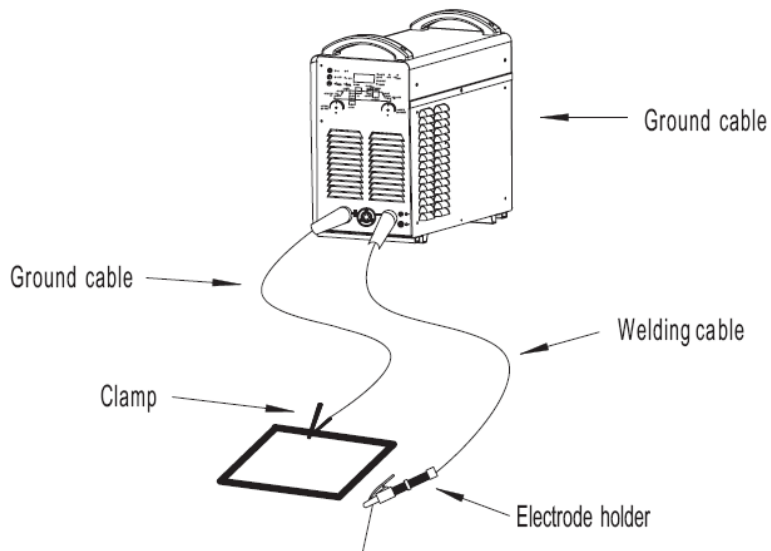



Fig. 4-6-7: SMAW welding connection

• **Hot start function**

In order to obtain optimum welding results, sometimes it is necessary to set this function. The advantages are as follows:

- Improved ignition, even when using electrodes with poor ignition properties;
- Better fusion of base metal in the start-up phase, meaning fewer cold crack defects;
- Greatly prevents slag inclusions.

• **The parameters for hot start function:**

**Hot start time** - In SMAW mode, press  button to enter into the hot start time selection menu, then turn  knob to adjust the hot start time (Range: 0.02~200S, factory setting: 0.50S).(Fig. 4-6-8)

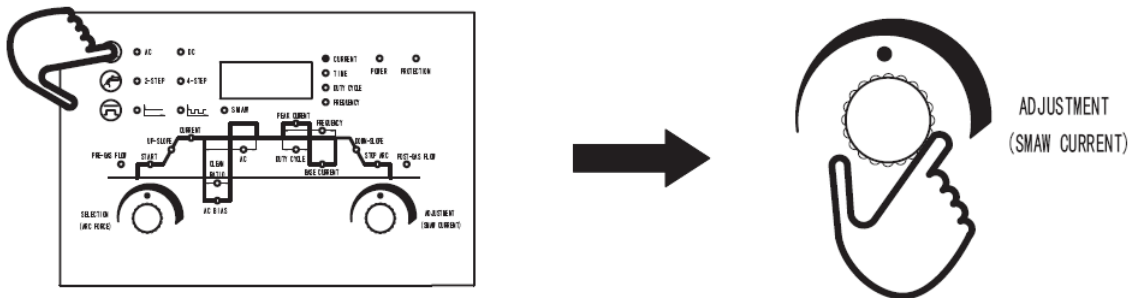



Fig. 4-6-8: Hot start time adjustment

**Hot start current** - In SMAW mode, press  button to enter into hot start current selection menu, then turn  knob to adjust the hot start current (Range: 10~200A, factory setting: 50A).(Fig. 4-6-9)

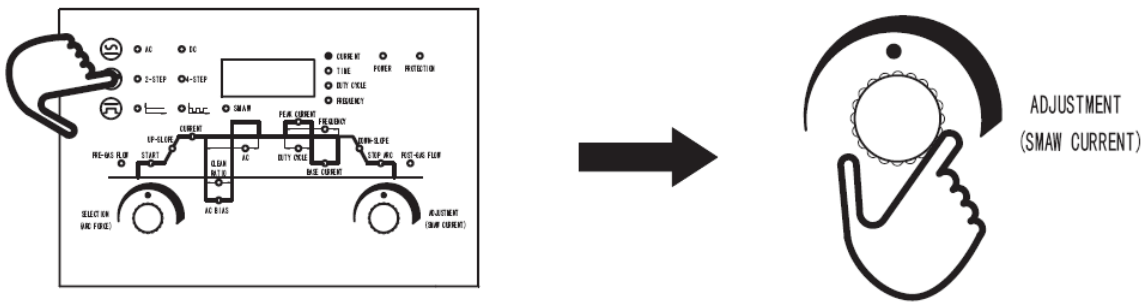

Fig. 4-6-9: Hot start current adjustment

• Example of hot start function:

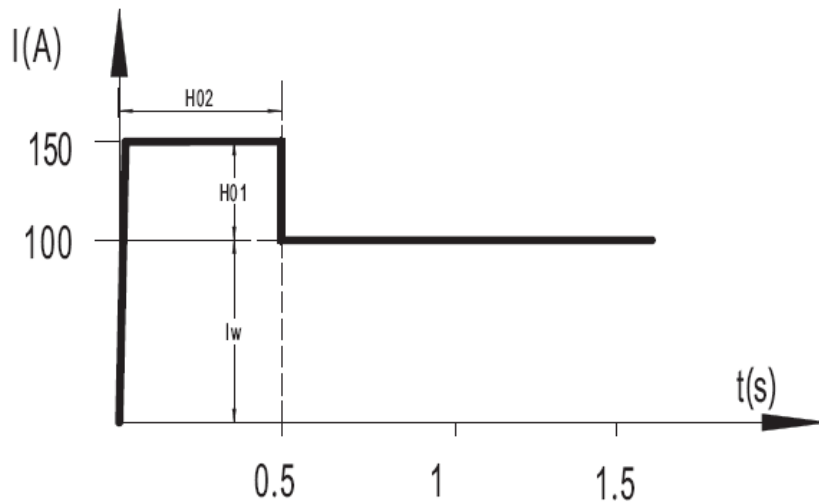

Fig. 4-6-10: Hot start function legend

**Legend:**

**I<sub>w</sub>** .....Preset welding current

**H02** .....Hot start time

**H01** .....Hot start current

During the preset hot start time (H02), the welding current increases to a certain value. The value (H01) is 10-200A higher than the preset welding current.

Example: A welding current of 100A has been set. For the hot start current (H01), 50A has been selected. During the hot start time (H02, such as 0.5s), the actual welding current will be 100A+50A=150A. (Fig. 4-6-10)

**4-7 Technical data**

**Note!** For machines designed for special voltages, below is the technical data on the name plate (as shown in Table 4-7-1 to Table 4-7-4).

**Single voltage**

| Model                         | Power TIG 3200 AC/DC DC Pulse |                 |                 |                 |
|-------------------------------|-------------------------------|-----------------|-----------------|-----------------|
| Rated input voltage/Frequency | 380V±10%/50 /60Hz             | 400V±10% /50 Hz | 415V±10% /50 Hz | 220V±10% /60 Hz |
| Rated input power (KVA)       | 9.3                           |                 |                 |                 |

|                        |                  |    |      |      |
|------------------------|------------------|----|------|------|
| Rated input current(A) | 20               | 19 | 18.3 | 34.5 |
| Duty cycle(%)          | 60               |    |      |      |
| Efficiency(%)          | 79               |    |      |      |
| Power factor           | 0.95             |    |      |      |
| Dimension(mm )         | 655×325×560      |    |      |      |
| Weight(Kg)             | 40               |    |      |      |
| Isolation degree       | Main transformer |    |      | H    |
|                        | Output reactor   |    |      |      |

Table 4-7-1: **Power TIG 3200 AC/DC DC Pulse** technical data-single voltage

### Multi voltage

| Model                         | Power TIG 3200<br>AC/DC DC Pulse  |
|-------------------------------|-----------------------------------|
| Rated input voltage/Frequency | 3 phase, AC<br>220/380/440V, 60Hz |
| Rated input capacity(KW)      | 13                                |
| Rated input current(A)        | 35/20/17                          |
| Rated duty cycle(%)           | 60                                |
| Voltage in open load (V)      | 95                                |
| Range of output current (A)   | 5-315                             |
| Arc-start current (A)         | 10-160                            |
| Peak current (A)              | 5-315                             |
| Crater fill current (A)       | 5-315                             |
| Up-slope time (s)             | 0.2-10                            |
| Down –slope time (s)          | 0.1-15                            |
| Pre-gas flow time (s)         | 0.1-15                            |
| Post-gas flow time (s)        | 0.1-60                            |
| Pulse frequency (Hz)          | 0.2-20                            |

|                       |                  |                |
|-----------------------|------------------|----------------|
| Pulse ratio           |                  | 1-100%         |
| AC frequency (Hz)     |                  | 20-200         |
| Pulse frequency (Hz)  |                  | 0.2-20         |
| Pulse width           |                  | 1-100%         |
| TIG mode              |                  | High frequency |
| Arc force current (A) |                  | 10-200         |
| Dimension(mm)         |                  | 655×325×560    |
| Weight(Kg)            |                  | 55             |
| Isolation degree      | Main transformer | H              |
|                       | Output reactor   |                |

Table 4-7-2: **Power TIG 3200 AC/DC DC Pulse** technical data-multi voltage

#### 4-8 Main components list

- **Power TIG 3200 AC/DC DC Pulse**

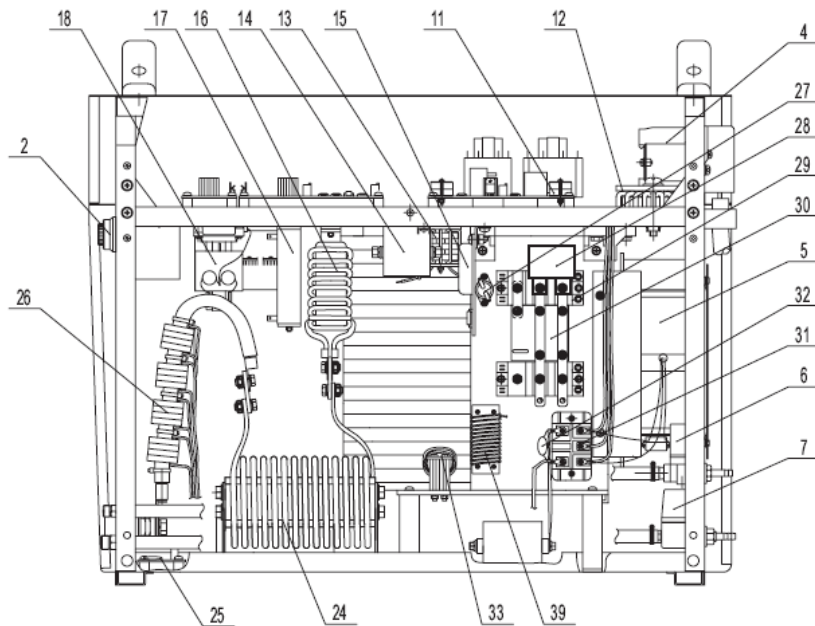

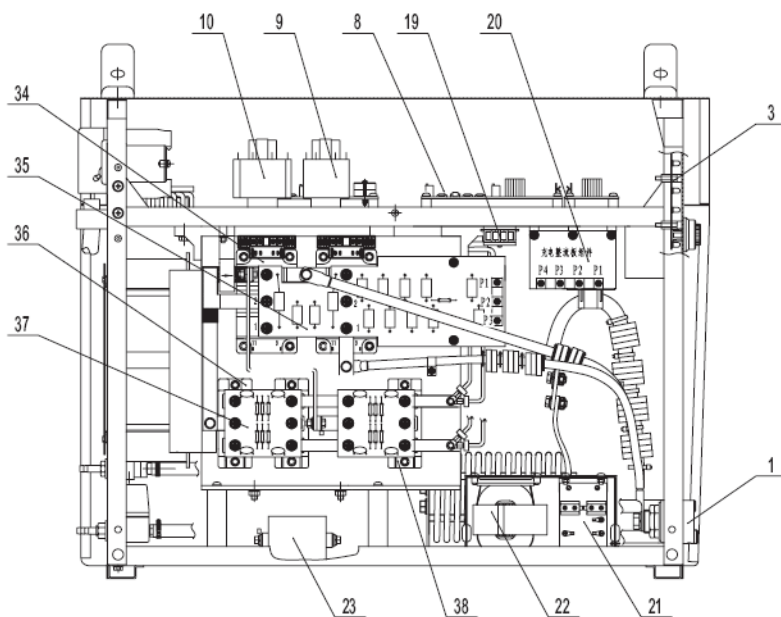

Fig. 4-8-1 : Inner structure

| No. | Item                               | Stock no.     | Remark    |
|-----|------------------------------------|---------------|-----------|
| 1   | Quick plug                         | 740002-00038, | 380V/50Hz |
|     |                                    | 740002-00037, | 380V/50Hz |
| 2   | Potentiometer                      | 720031-00071, | 380V/50Hz |
| 3   | Display board                      | 220503-00017, | 380V/50Hz |
| 4   | Circuit breaker                    | 745011-00021, | 380V/50Hz |
| 5   | Fan                                | 746001-00017, | 380V/50Hz |
|     |                                    | 746001-00035, | 400V/50Hz |
|     |                                    | 746001-00019, | 415V/50Hz |
|     |                                    | 746001-00018, | 460V/60Hz |
| 6   | Solenoid valve                     | 752001-00007, | 380V/50Hz |
| 7   | Water flow switch                  | 745005-00003, | 380V/50Hz |
| 8   | Main control board                 | 210580-00108, | 380V/50Hz |
| 9   | Power transformer                  | 763001-00043, | 380V/50Hz |
|     |                                    | 763001-00052, | 400V/50Hz |
|     |                                    | 763001-00060, | 415V/50Hz |
|     |                                    | 763001-00047, | 460V/60Hz |
| 10  | AC/DC power transformer I          | 763003-00017, | 380V/50Hz |
|     |                                    | 763003-00012, | 400V/50Hz |
|     |                                    | 763003-00014, | 415V/50Hz |
|     |                                    | 763003-00167, | 460V/60Hz |
| 11  | Drive board                        | 210310-00032, | 380V/50Hz |
| 12  | Input anti-common-mode inductor    | 220467-00011, | 380V/50Hz |
| 13  | Resonant inductor                  | 220521-00006, | 380V/50Hz |
| 14  | Polypropylene capacitor 4uf 500VAC | 722001-00073, | 380V/50Hz |
| 15  | Current transformer                | 220149-00028, | 380V/50Hz |
| 16  |                                    | 220629-00018, | 380V/50Hz |

|    |  |               |           |
|----|--|---------------|-----------|
|    | Main transformer                       | 220629-00189, | 460V/60Hz |
| 17 | Wire-wound resistor 50W, 30Ω           | 720005-00028  | 380V/50Hz |
| 18 | Isolation transformer                  | 763003-00023  | 380V/50Hz |
| 19 | Charging inductor                      | 220095-00001  | 380V/50Hz |
| 20 | Charging rectifier board               | 220089-00004  | 380V/50Hz |
| 21 | Arc starting board                     | 220575-00003  | 380V/50Hz |
| 22 | High leakage reactance transformer     | 763003-00018  | 380V/50Hz |
| 23 | Polypropylene capacitor 20uf 1400V     | 722001-00070  | 380V/50Hz |
| 24 | Output reactor                         | 763004-00112  | 380V/50Hz |
| 25 | Rack capacitor board                   | 220293-00023  | 380V/50Hz |
| 26 | Voltage boosting transformer           | 220431-00014  | 380V/50Hz |
| 27 | Temperature relay                      | 745008-00006  | 380V/50Hz |
| 28 | Polypropylene capacitor 0.47uf,1200VAC | 722001-00067  | 380V/50Hz |
| 29 | IGBT module                            | 735007-00046  | 380V/50Hz |
| 30 | IGBT protection board                  | 220005-00089  | 380V/50Hz |
| 31 | Three phase rectifier board            | 735005-00010  | 380V/50Hz |
| 32 | Varistor                               | 720021-00017  | 380V/50Hz |
|    |  | 720021-00021  | 415V/50Hz |
|    |  | 720021-00001  | 460V/60Hz |
| 33 | Current exchange inductor              | 220281-00008  | 380V/50Hz |
| 34 | Secondary IGBT components              | 220221-00001  | 380V/50Hz |
| 35 | Secondary IGBT protection board        | 220215-00001  | 380V/50Hz |
| 36 | Output diode module MMF200S060DK       | 735006-00055  | 380V/50Hz |
| 37 | Diode protection board                 | 220233-00004  | 380V/50Hz |
| 38 | Output diode module MMF200S060DA       | 735006-00056  | 380V/50Hz |
| 39 | Commutating inductor                   | 220287-00001  | 380V/50Hz |

Table 4-8: Main components list

## 5-Power TIG 3200 AC/DC DC Pulse

### 5-1 System components

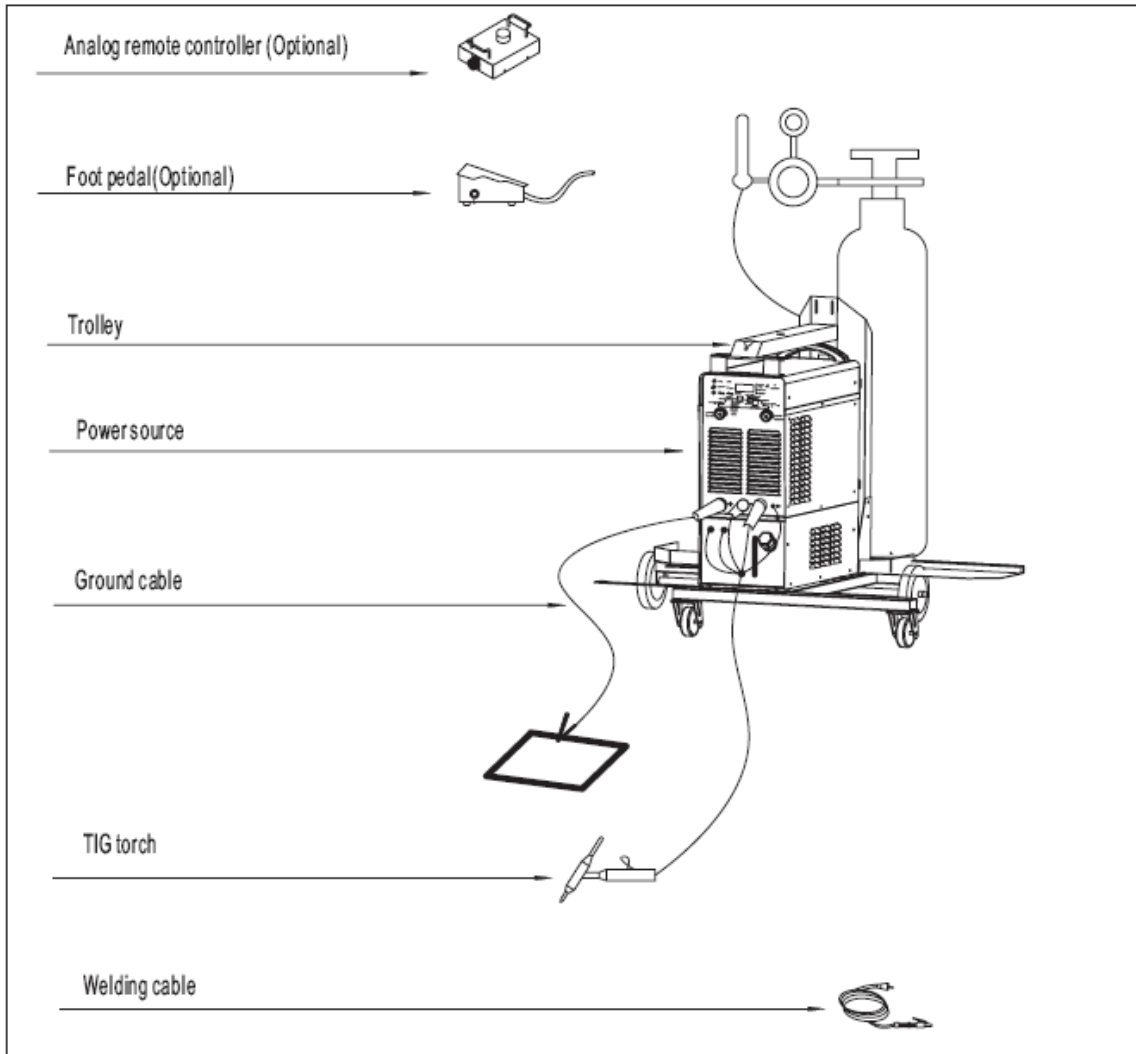

Fig. 5-1-1: System components

### 5-2 Basic equipments for welding

Please refer to " Power TIG 3200 AC/DC DC Pulse " the relevant "Basic equipments for welding" in detail.

### 5-3 Control panel

The functions on the control panels are all arranged in a logical way, and the welding waveforms make the operation easier and convenient. The parameters can be easily selected and adjusted by the button and knob (Fig. 5-3-1).

**Note!** Your machine has certain functions that are not in accordance with this operating manual, or vice versa. Also, certain illustrations may be slightly different from the actual controls on your machine. However, these controls function are exactly in the same way.

**Warning!** Operating the equipment incorrectly can cause serious injury and damage. Do not use the functions described here until you have read and completely understood this operating manual.

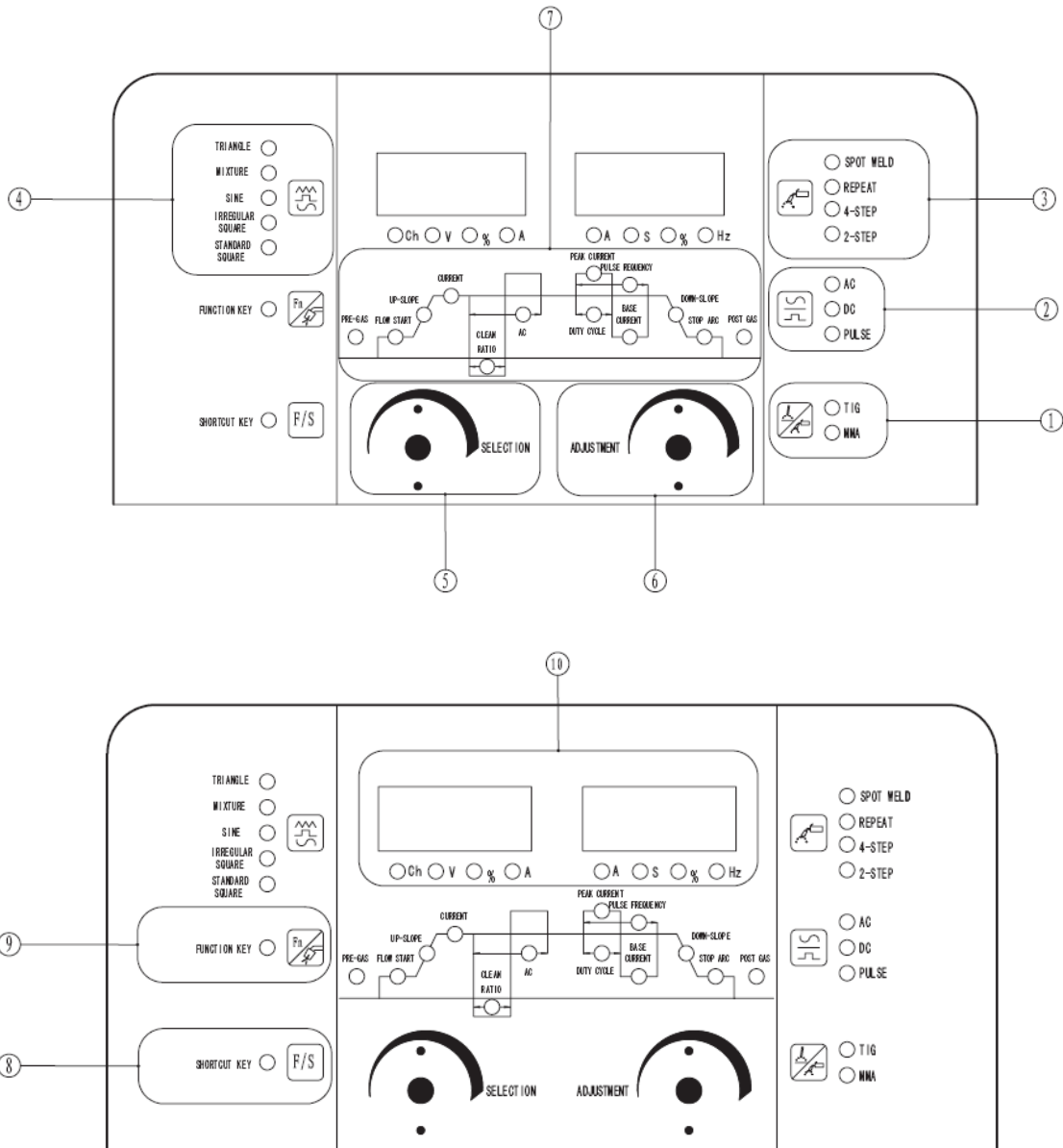

Fig. 5-3-1: Control panel

①



Press the button to switch between TIG and MMA, the indicator for the selected progress will light up.

②

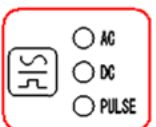



In TIG process, press the button to select AC, AC pulse, DC and DC pulse (Fig. 5-3-2).

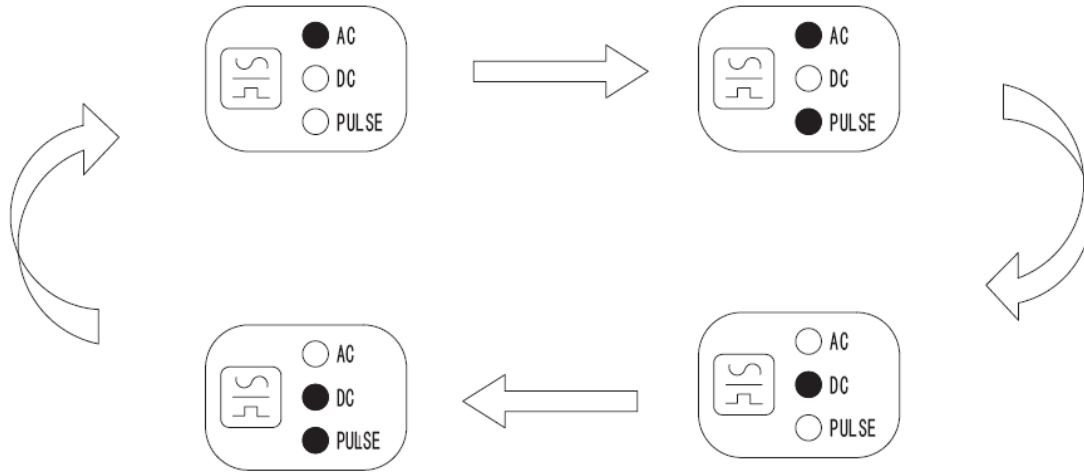
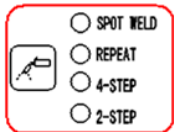

Fig. 5-3-2: AC, AC pulse, DC and DC pulse selection

- When AC mode is selected, the AC indicator lights up
- When AC Pulse mode is selected, the AC and PULSE indicators both light up
- When DC mode is selected, the DC indicator lights up
- When DC Pulse mode is selected, the DC and PULSE indicators both light up

③



- In TIG mode, press the button to select spot weld, repeat, 4-step and 2-step, the relevant indicator will light up (Fig. 5-3-3).

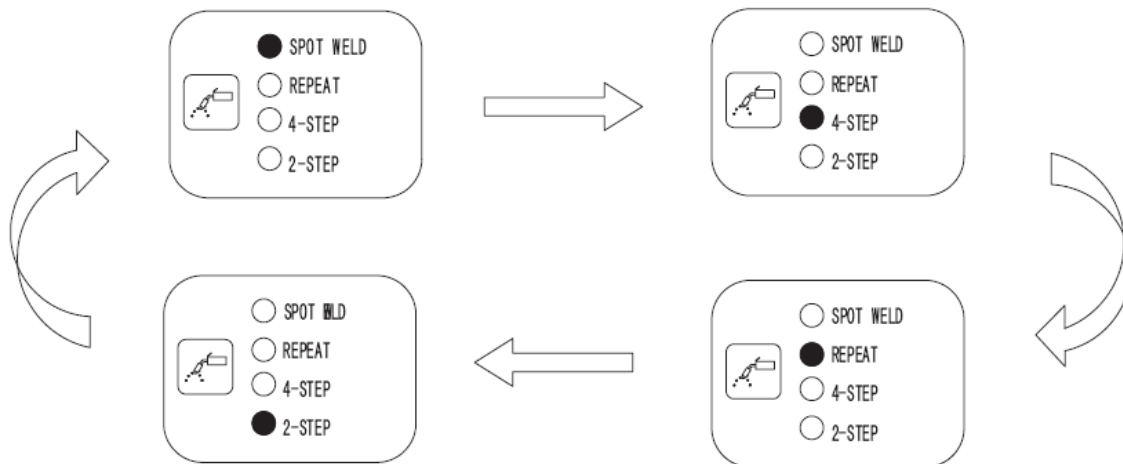

Fig. 5-3-3: Spot weld, repeat, 4-step and 2-step selection

**Torch operation mode:**

**Legend:**

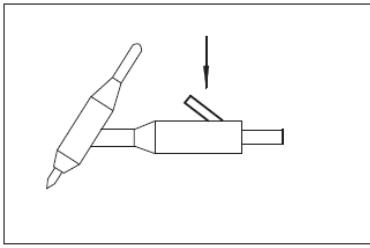

Fig. 5-3-4: Press torch trigger

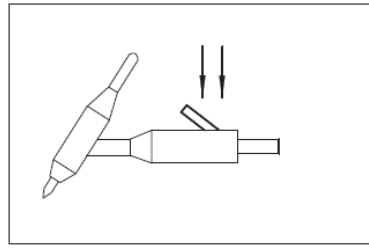

Fig. 5-3-5: Hold torch trigger

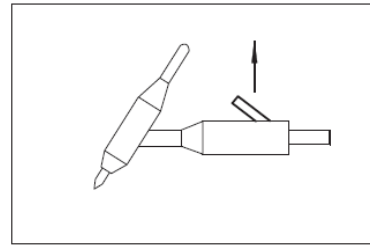

Fig. 5-3-6: Release torch trigger

### 2-step and 4-step operation modes

For 2-step and 4-step operation mode, please refer to "ATIG-PAC-315/500/630" the relevant "Torch operation modes" in detail.

### Repeat mode (Fig. 5-3-7):

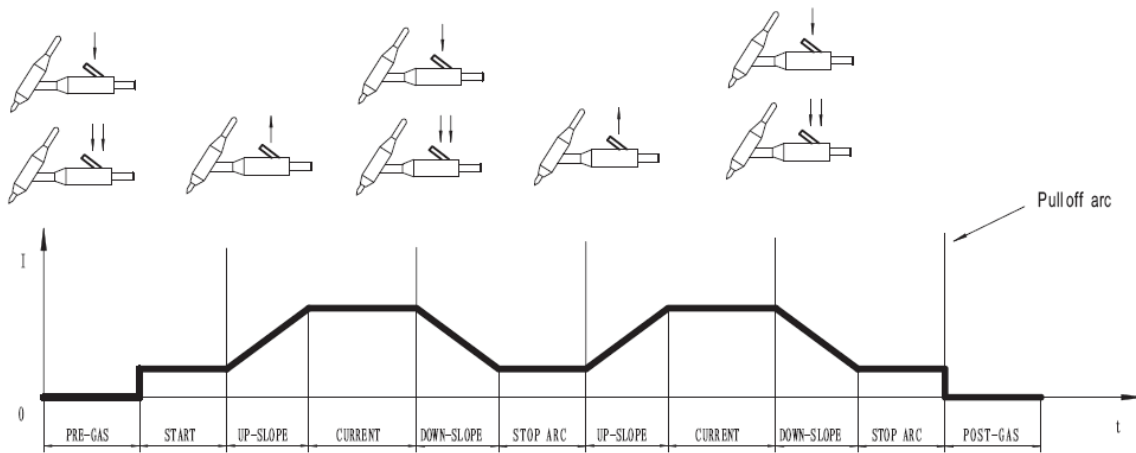

Fig. 5-3-7: Repeat mode

a. Press and hold torch trigger to start welding.

- Open solenoid valve to start flow of shielding gas, to expel air from torch hose (pre-gas time can be set depending on hose length), then the HF ignition device start the arc.
- The machine begins to output initial current; this current can be maintained until releasing the torch trigger.

b. Release torch trigger.

- The output current is continuously increased from initial current to welding current; the time of this process is called upslope time.
- If the initial current is not required, it will not need to hold the torch trigger. Quickly release it after the arc is started, the output current will increase to welding current.

c. When finishing a part of welding, press again and hold torch trigger.

- The output current is continuously lowered at a certain rate until it reaches to crater-filler current; the time of this process is called down slope time.
- The crater-filler current can be maintained until pressing and releasing the torch trigger again.

d. Release the trigger to repeat step 2.

e. When finishing another part of welding, press and hold torch trigger again, step 3 will be repeated.

f. When finish welding, lift the torch away from the work piece until the arc goes out. The solenoid valve will continue to operate for the selected time (post-gas time), allowing the shielding gas to protect tungsten electrode and molten pool. Then the solenoid valve stops running, gas stops and the welding is completed.

### Spot weld mode (Fig. 5-3-8):

- a. Press and hold torch trigger to start welding.
- Open solenoid valve to start flow of shielding gas so as to expel air from torch hose (pre-gas time can be set depending on hose length), then the HF ignition device starts the arc.
  - Output current increases from initial current to welding current.
- b. When the spot weld time reaches to the preset time, the welding current is continuously lowered during preset down slope time until it reaches to crater filler current, then to zero. At this time, the solenoid valve will continue to operate for the selected time (post-gas time), allowing the shielding gas to protect tungsten electrode and molten pool. Then the solenoid valve stops running, gas stops, and the welding completes.

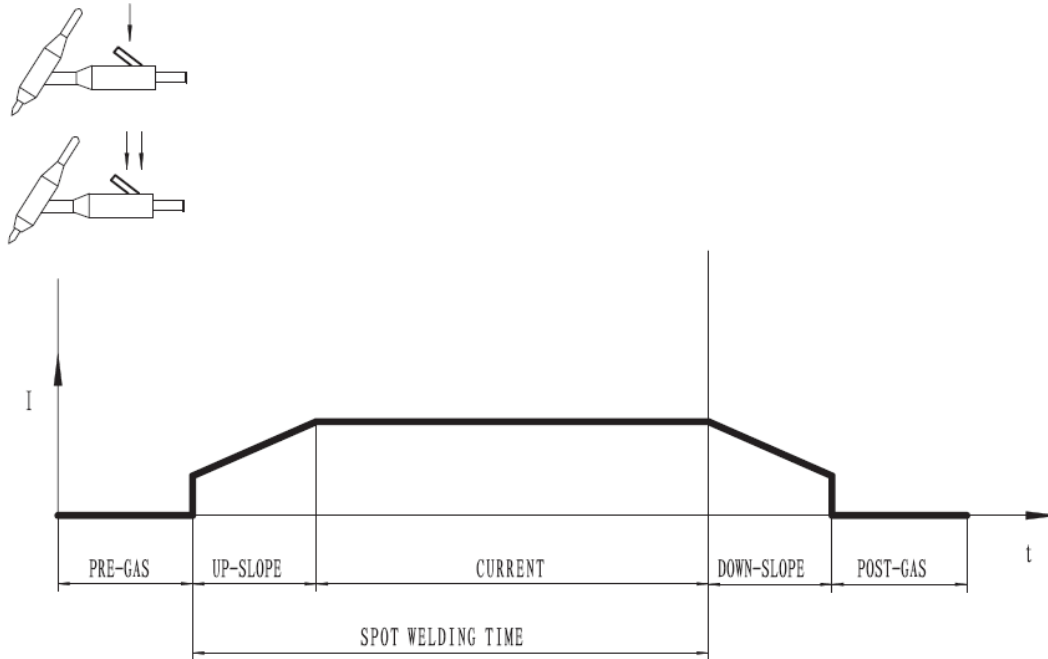
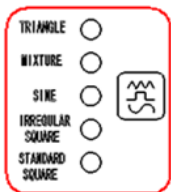

Fig. 5-3-8: Spot weld mode

④



In AC TIG mode, press the button to select standard square wave, irregular square wave, sine wave, mixture wave or triangle wave, and the relevant indicator will light up (Fig. 5-3-9).

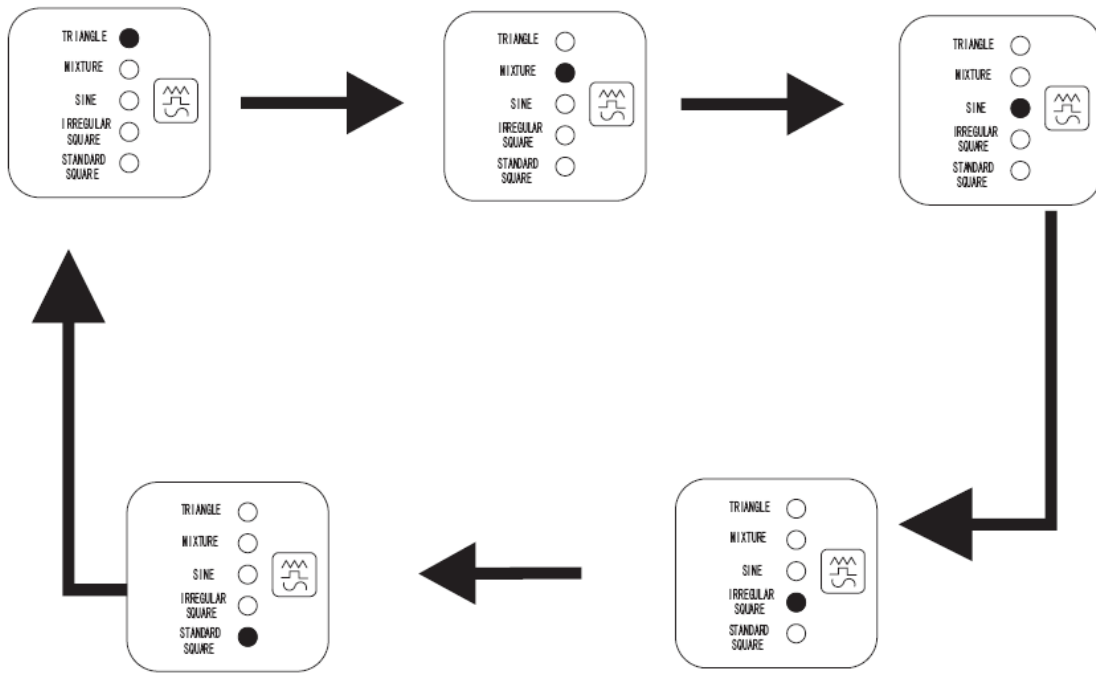

Fig. 5-3-9: Wave form selection

**Five AC waveforms:**

**Standard square wave:** Responsive arc with fast zero crosses and reduced peak current. Stable arc with good puddle control and fast travel speed, Minimizes tungsten superheating. (Fig. 5-3-10)

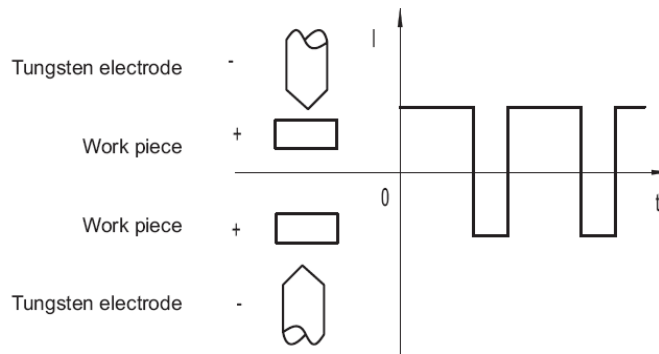

Fig. 5-3-10: Standard square wave

**Irregular square wave:** Stronger arc with slow zero crosses and lose noise; the strongest arc and deep penetration, less noise. (Fig. 5-3-11)

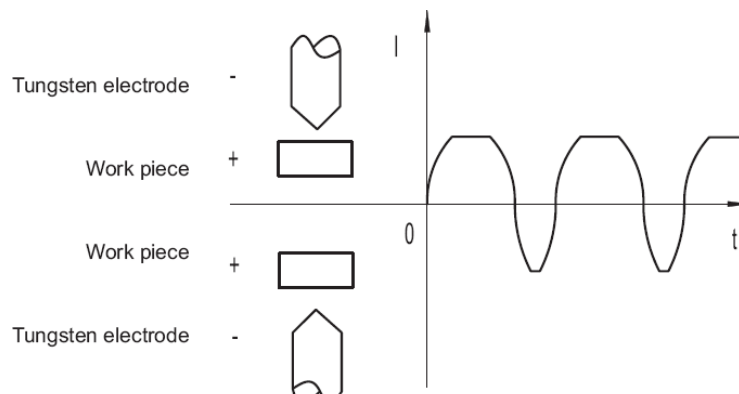

Fig. 5-3-11: Irregular square wave

**Sine wave:** Traditional smooth shaped waveform. Soft arc and less noise. Good for wide seam. (Fig. 5-3-12)

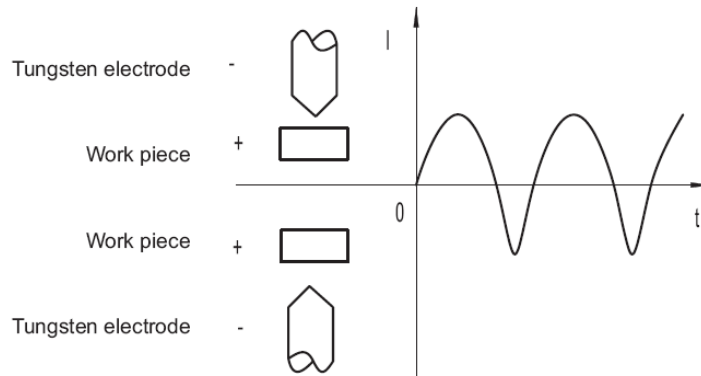

Fig. 5-3-12: Sine wave

**Triangle wave:** Minimized area (heat) under the curve shape with high peaks. Lower amperages can minimize heat input to the weld. High peaks more forceful for anodized applications. (Fig. 5-3-13)

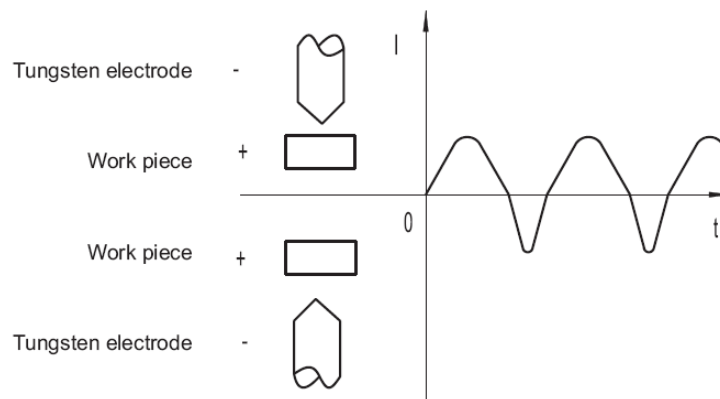

Fig. 5-3-13: Triangle wave

**Mixture wave:** Alternate output AC current and DC current, high Efficiency. (Fig. 5-3-14)

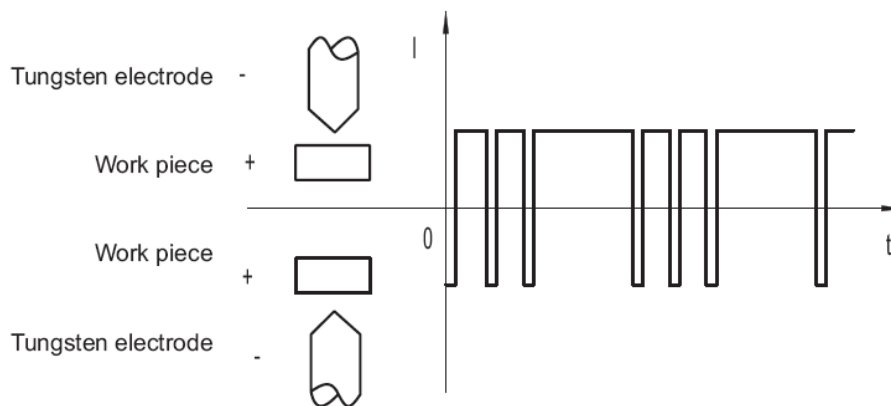

Fig. 5-3-14: Mixture wave



⑤



- In TIG mode, it is used for selecting parameters in waveforms on panel. Turn it clockwise to select from left to right; turn it anticlockwise to select from right to left.
- In SMAW mode, it is used for adjusting the arc force, press the button and turn left or right for quick adjustment.

⑥



- In TIG mode, it is used for adjusting parameters in waveforms on panel. When the parameter is selected by , turn  clockwise to increase the value; turn  anticlockwise to decrease the value. Press the button and turn left or right for quick adjustment.

- In SMAW mode, it is used for adjusting welding current; press the button and turn left or right for quick adjustment.

⑦

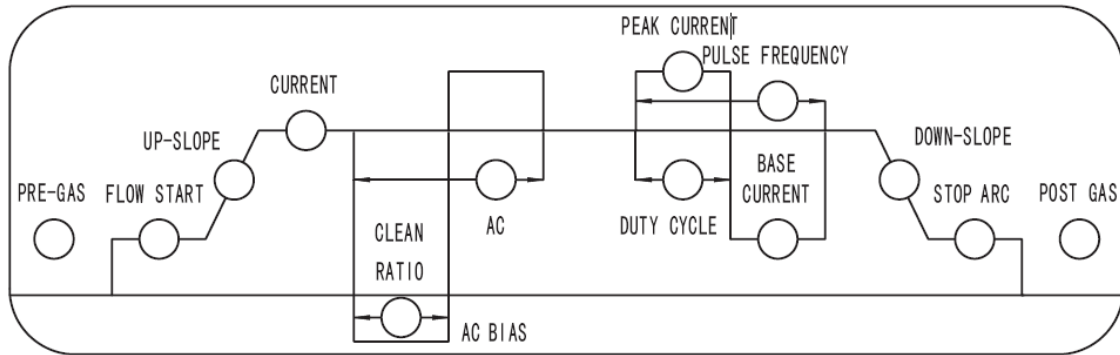

|  |
|--|
| <p><b>PRE-GAS</b></p> <p>- Time of gas flow before welding.</p> <p>Unit: S</p> <p>Range: OFF~10.0</p> <p>Factory setting: 0.2</p>  |
| <p><b>START</b></p> <p>- The initial current.</p> <p>Unit: A</p> <p>Range: 5~315 (Power TIG 3200 AC/DC DC Pulse)</p> <p>Factory setting: 40 (Power TIG 3200 AC/DC DC Pulse)</p>  |
| <p><b>UP-SLOPE</b></p> <p>- Time that current output increases from arc starting current to welding current.</p> <p>Unit: S</p> <p>Range: 0.1~10</p> <p>Factory setting: 0.1</p>   |
| <p><b>CURRENT</b></p> <p>- The welding current in SMAW, AC TIG and DC TIG, supplying uniform thermal input into base metal.</p> <p>Unit: A</p> <p>Range: 5~315 (Power TIG 3200 AC/DC DC Pulse)</p> <p>Factory setting: 100</p> |
| <p><b>CLEAN RATIO</b></p> <p>- Time ratio of clean current in AC mode.</p>   |

Unit: %

Range: -40~+40

Factory setting: 0

In AC TIG welding, the clean ratio can be adjusted in order to alter the width of oxide surface and the size of penetration for excellent welding result. The adjustment effect is as shown in Fig. 7-3-15:





|                              |   |   |
|------------------------------|---|---|
| <b>Clean ratio</b>           |  |  |
| <b>Weld effect</b>           |  |  |
| <b>Waveform</b>              |  |  |
| <b>Electrode consumption</b> | <b>Less</b>   | <b>More</b>   |

Fig. 5-3-15: Clean ratio adjustment

AC

- The frequency of welding current in AC mode.

Unit: Hz

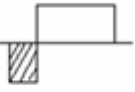
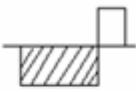
Range: 40~250 (Power TIG 3200 AC/DC DC Pulse)

Factory setting: 60

PEAK CURRENT

- The peak current in DC pulse or AC pulse mode.

Unit: A

Range: 5~315 (Power TIG 3200 AC/DC DC Pulse)

Factory setting: 100

DUTY CYCLE

- The time proportion of peak current in single cycle on DC pulse or AC pulse mode, can be used for controlling penetration in all-position or thin sheet welding.

Unit: %

Range: 15~85

Factory setting: 40

**Important!** In AC mixture waveform output, the duty cycle range is 15-85.

FREQUENCY

- The frequency of welding current in DC pulse or AC pulse mode.

Unit: Hz

Range: 0.2~999 (Power TIG 3200 AC/DC DC Pulse)

Factory setting: 4.0

**Important!** In AC mixture waveform output, the pulse frequency range is 0.5-10Hz.

BASE CURRENT

- The arc maintenance current in DC pulse or AC pulse mode.

Unit: A

Range: 5~315 (Power TIG 3200 AC/DC DC Pulse)

Factory setting: 10/20



DOWN-SLOPE

|  |
|--|
| - Time that welding current is continuously lowered until it reaches to crater filler current.<br>Unit: S<br>Range: 0.1~15<br>Factory setting: 0.4 |
| STOP ARC<br>- The current before arc blowout.<br>Unit: A<br>Range: 5~315 (Power TIG 3200 AC/DC DC Pulse)<br>Factory setting: 40/80                 |
| POST-GAS<br>- Time of gas flow after arc blowout.<br>Unit: S<br>Range: OFF~60.0<br>Factory setting: 15.0   |



⑧



Press the button to select fast or slow adjustment.

**Fast adjustment** - Press the button and the indicator is light off to enter into fast adjustment. The parameters can be adjusted by  and . For adjustable parameters, please see below table, other parameters are sub-menu parameters and can't be adjusted.

**Slow adjustment** - Press the button and the indicator is light up to enter into slow adjustment, and all the parameters can be adjusted. For the detailed operation, please refer to the introduction of panel ⑤ and ⑥.

In fast adjustment, the parameters that can be adjusted by  and , as shown in Table 5-3-1.

| Process  | Parameter selection knob | Parameter adjustment knob |
|----------|--------------------------|---------------------------|
| DC       |                          | CURRENT                   |
| DC pulse | DUTY CYCLE               | PEAK CURRENT              |
| AC       | CLEAN RATIO              | CURRENT                   |
| AC pulse | DUTY CYCLE               | PEAK CURRENT              |
| SMAW     | ARC FORCE                | CURRENT                   |

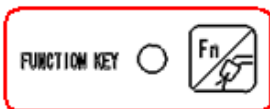

Table 7-3-1: Fast adjustment

⑨



a. Press the button (release it within 5s) and the indicator lights up to enter into sub-menu parameter adjustment.



Turn  to select "parameter code" and turn  to adjust parameter value.

**Important!** In sub-menu parameter adjustment, the welding machine can't work. Do not adjust sub-menu parameters when welding machine is in use!

- b. Press the button again (release it within 5s) and the indicator lights off to exit from sub-menu parameter adjustment.
- c. Press the button (for more than 5s) and release it to enter gas test, the gas valve starts to flow of shielding gas and stop automatically after 30s to exit from gas test. Press the button again within 30s to stop flow of shielding gas and exit from gas test.

**Sub-menu parameters:**

**Sub-menu parameter codes (Table 5-3-2):**

| Process            | Sub-menu Parameter          | Code        | Setting range | Default value |
|--------------------|-----------------------------|-------------|---------------|---------------|
| TIG                | Tungsten electrode diameter | ELd         | 0.8~6.0(mm)   | 2.0mm         |
|                    | Torch type                  | H2O         | ON            | ON            |
|                    |                             |             | OFF           |               |
|                    | Channel selection           | CHA         | n0~n29        | n0            |
|                    | HF selection                | HF          | on            | on            |
|                    |                             |             | oFF           |               |
| Arc-start polarity | P~S                         | PoS<br>nEG  | nEG           |               |
| Spot weld time     | SPt                         | 0.1~10.0(s) | 0.1s          |               |
| SMAW               | Hot start current           | HCu         | 20~200(A)     | 50A           |
|                    | Hot start time              | Hti         | 0.1~2.0(s)    | 0.5s          |
|                    | Knee point voltage          | UIn         | 15~30(V)      | 15V           |
| Timing function    |                             | t-L         | 0000:00~      | 000           |
|                    |                             | t-H         | 9999:59       | 000           |
| Factory setting    |                             | FAC         | no            | YES           |
|                    |                             |             | YES           |               |

Table 5-3-2: Sub-menu parameter codes

**Tungsten electrode diameter (Eld)** - In TIG mode, suitable tungsten electrode diameter is selected to achieve better arc-start and welding performance.

Unit: mm

Range: 0.8~6.0



Factory setting: 2.0

**Torch type (H2O)** - In TIG mode, it refers to gas-cooled torch or water-cooled torch. If water-cooled torch is used, please select "on"; if gas-cooled torch is used, please select "off".

Range: on/off

Factory setting: on

**Important!** If the machine is on water shortage protection, the sub-menu parameter adjustment is not available and troubleshooting is necessary. If the machine is normal, sub-menu is available. If the water shortage alarm is

displayed, the torch type should be forcibly changed, that is press and hold  and  at the same

time for 5s and water shortage error code "E09" disappears, meaning the torch type has changed from "on" to "off".

**Channel selection (CHA)** - In TIG mode, the welders need to write down technical parameters for some repeated jobs. Thanks to this function, up to 30 job records can be stored and loaded.

Range: n0~n29

Factory setting: n0

**Proceed as follows:**

**Create a job**



Ch  V  %  A

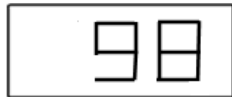

A  S  %  Hz

a. Set the parameter to be stored;



Ch  V  %  A

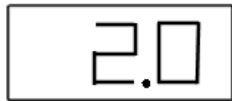

A  S  %  Hz

b. Press  (release it within 5s) and the indicator lights up to enter into sub-menu parameter adjustment;



Ch  V  %  A



A  S  %  Hz

c. Select code "CHA" by ;



Ch  V  %  A

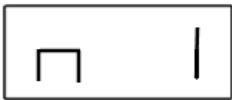

A  S  %  Hz

d. Select channel No "n0~n29" by ;



Ch  V  %  A

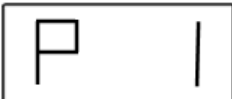

A  S  %  Hz

e. Press  for 3s and the channel No is changed from "n0~n29" to "P0~P29", meaning the present job parameter has been stored;

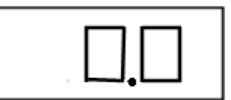

Ch  V  %  A

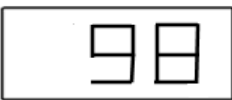

A  S  %  Hz

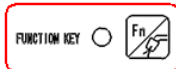
d. Press  again (release it within 5s) and the indicator lights off to exit from the sub-menu parameter adjustment, the job creation is completed.

**Call a job**



Ch  V  %  A

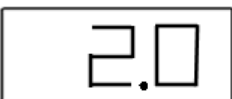

A  S  %  Hz

a. Press  (release it within 5s) and the indicator lights up to enter into the sub-menu parameter adjustment.



Ch  V  %  A

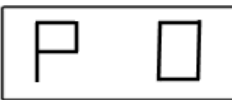

A  S  %  Hz

b. Select code "CHA" by ;



Ch  V  %  A

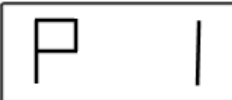

A  S  %  Hz

c. Select channel No "P0~P29" by ;

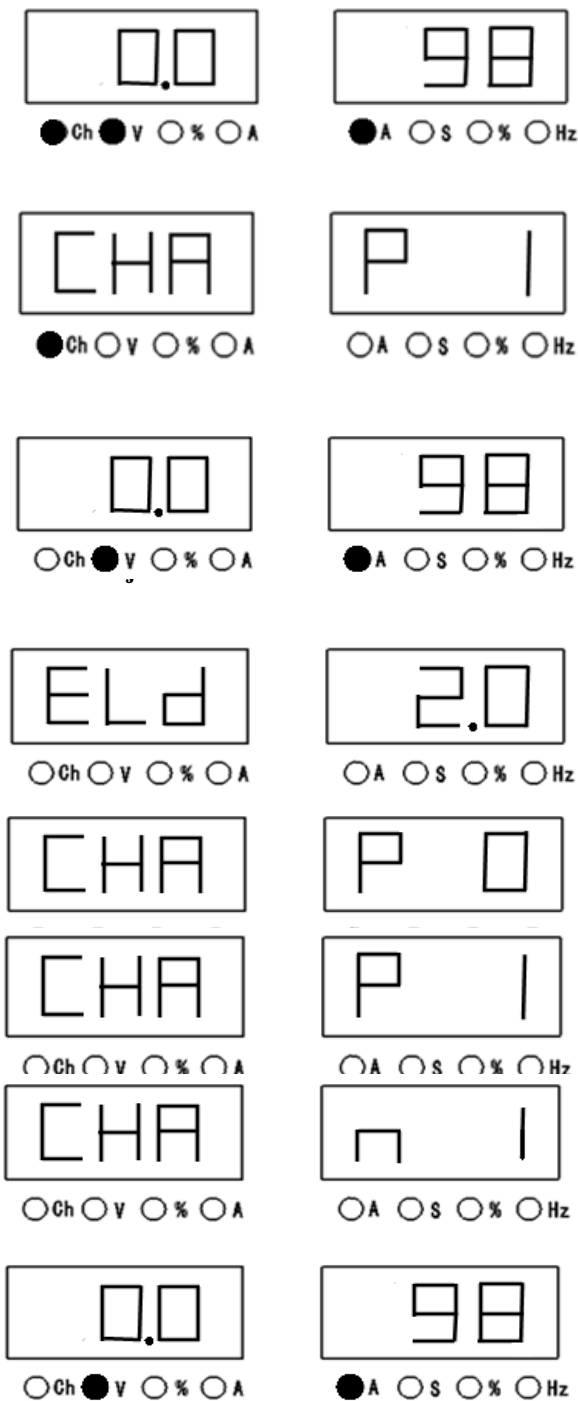

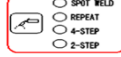
d. Press  and Ch indicator lights up, meaning the job parameter which stored in present channel is loaded. At this time, the knobs and buttons on the panel are locked and the present parameters can't be changed.

e. Press  again (release it within 5s) and the indicator lights off to exit from job loading; the present job parameters can be used for welding and the job loading is completed;

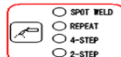
f. In call mode, press  again and Ch indicator lights off, cancel the present call state and the panel is unlocked.

a. Press  (release it within 5s) and the indicator lights up to enter into sub-menu parameter adjustment;

b. Select code "CHA" by ;

c. Select channel No "P0~P29" by  ;

d. Press  for 3s, the channel No is changed from "P0~P29" to "n0~ n29", meaning the job parameter which is stored in present channel is deleted;

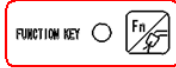
e. Press  again (release within 5s) and the indicator lights off to exit from "delete job", the job deletion is completed.

**Important!** When the machine is switch off, the present parameters are automatically saved and can be used when the machine is switch on next time.

**High frequency (HF)** – Used for selecting ignition mode in TIG. If high frequency ignition is to be used, select "ON"; if scratch ignition is to be used, select "OFF".

Range: on/off

Factory setting: on

**Arc-start polarity (P-S)** – Select torch polarity when starting arc in DC TIG mode. If positive polarity is to be used, select "PoS"; if negative polarity is to be used, select "nEG".

Range: PoS/nEG  
Factory setting: nEG

**Spot weld time (SPT)** – Used for setting spot weld time in TIG mode. The welding will stop if release torch trigger within the spot weld time.

Unit: S  
Range: 0.1~10.0  
Factory setting: 0.1

**Hot start current (Hcu)** - Select hot start current in SMAW mode.

Unit: A  
Range: 20~200  
Factory setting: 50

Hot start time (Hti) - Select hot start time in SMAW mode.

Unit: S  
Range: 0.1~2.0  
Factory setting: 0.5

**Important!** For the explanation of hot start current and hot start time in SMAW mode, please refer to "ATIG-PAC-315/500/630" the relevant "Hot start function" in detail.

**Knee point voltage (UIn)** –select knee point voltage in SMAW mode (Fig. 7-3-16).

Unit: V  
Range: 15~30  
Factory setting: 15

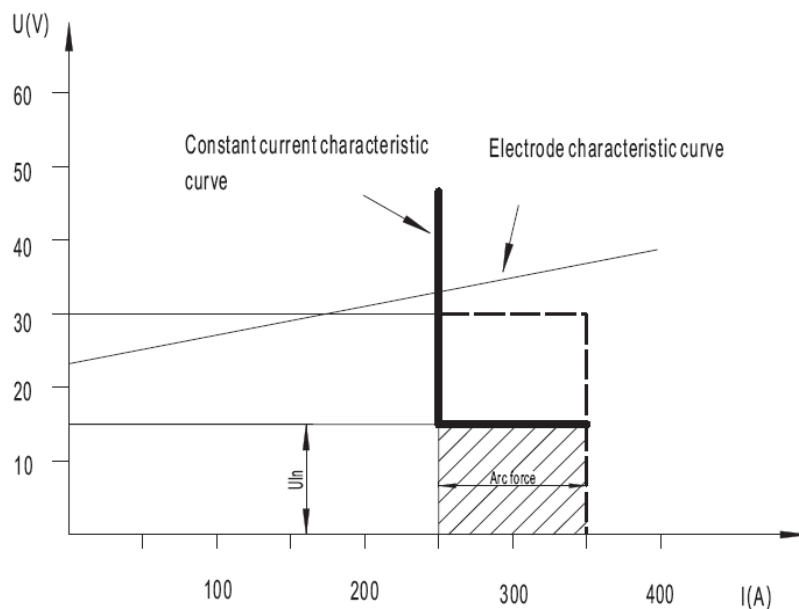



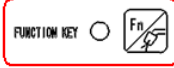

Fig. 5-3-16: Knee point voltage (UIn)

**Timing function** – The accumulated running time of machine. The time can be cleared and re-accumulate.

Unit: hr./min.  
Range: 0~9999:59  
Factory setting: 000

**Proceed as follows:**

- a. Press  (release with 5s) and the indicator lights up to enter into sub-menu parameter adjustment;
- b. Select code "t-L" or "t-H" by  to check specific value. "t-L" indicates the low-order value and "t-H" indicates the high-order value.  
Combine both values to read the timing time;
- c. If you want to zero clearing the time, press  for 3s and the value becomes zero;
- d. Press  again (release it within 5s) and the indicator lights off to exit from timing function.

Example: If the high-order and low-order are shown as Fig. 7-3-17, meaning the timing time is 9933:20, it is nine thousand nine hundred and thirty-three hours and twenty minutes.

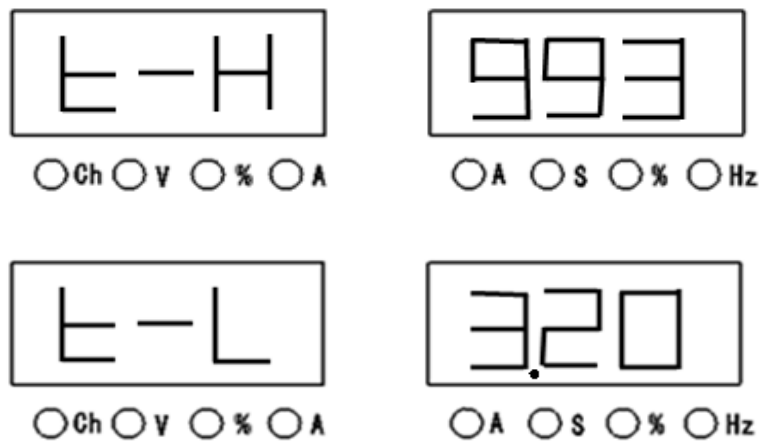





Fig. 7-3-17: Displayed time

**Factory setting (FAC)** - Reset power source to factory setting. When "no" appears, the power source hasn't been restored to factory setting; when "YES" appears, it has been restored to factory setting.

Range: no/YES

Factory setting: YES

**Proceed as follows:**

- a. Press  (release within 5s) and the indicator lights up to enter into sub-menu parameter adjustment;
- b. Select code "FAC" by ;
- c. Press  for 3s and "YES" appears on right-hand displayer, the factory setting is restored.
- d. Press  again (release within 5s) and the indicator lights off to exit from factory setting, and the factory setting is completed.

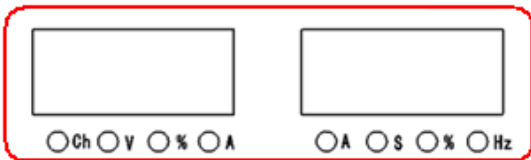

Used for displaying the welding current, voltage and other parameters. If different parameters are selected, the relevant indicator will light up.

### 5-4 Interface

- Interface on front panel

For the interface on front panel of this series, please refer to "ATIG315/500/630PAC" the relevant "Interface on front panel" in detail.

- Interface on rear panel (Table 5-4-1)

Fig. 5-4-1:

| Power TIG 3200 AC/DC DC Pulse | No. | Item                  |
|-------------------------------|-----|-----------------------|
|                               | 1.  | Circuit breaker       |
|                               | 2.  | Terminal box          |
|                               | 3.  | Fuse (2A)             |
|                               | 4.  | Nameplate             |
|                               | 5.  | Fan                   |
|                               | 6.  | Gas inlet (M12×1)     |
|                               | 7.  | Water inlet (M16×1.5) |
|                               |     |                       |
|                               |     |                       |
|                               |     |                       |
|                               |     |                       |
|                               |     |                       |
|                               |     |                       |
|                               |     |                       |
|                               |     |                       |

Interface on rear panel

### 5-5 Water-cooling system

Please refer to " Power TIG 3200 AC/DC DC Pulse " the relevant "Water-cooling system" in detail.

## 5-6 Installation and operation

Please refer to " Power TIG 3200 AC/DC DC Pulse " the relevant "Installation and operation" in detail.

## 5-7 Technical data



**Note!** For machines designed for special voltages, the technical data on the rating plate applies (Table 5-7-1- Table 5-7-4.).

Single voltage

| Model                         | Power TIG 3200 AC/DC DC Pulse |                |                |   |
|-------------------------------|-------------------------------|----------------|----------------|---|
| Rated input voltage/Frequency | 380V±10 % /50 /60Hz           | 400V±10%/50 Hz | 415V±10%/50 Hz | / |
| Rated input power(KVA)        | 9.3                           |                |                |   |
| Rated input current(A)        | 20                            | 19             | 18.3           | / |
| Duty cycle(%)                 | 60                            |                |                |   |
| Efficiency(%)                 | 79                            |                |                |   |
| Power factor                  | 0.95                          |                |                |   |
| Dimension(mm)                 | 636×322×560                   |                |                |   |
| Weight(Kg)                    | 53                            |                |                |   |
| Isolation degree              | Main transformer              |                | H              |   |
|                               | Output reactor                |                |                |   |

Table 5-7-1: **Power TIG 3200 AC/DC DC Pulse** technical data –single voltage

Multi voltage

| Model                         | Power TIG 3200 AC/DC DC Pulse  |
|-------------------------------|--------------------------------|
| Rated input voltage           | 3 phase, AC 220/380/440V, 60Hz |
| Rated input capacity(KW)      | 13                             |
| Rated input current(A)        | 35/20/17                       |
| Rated duty cycle(%)           | 60                             |
| Max. open circuit voltage (V) | 95                             |
| Range of output current (A)   | 5-315                          |
| Arc-start current (A)         | 10-160                         |
| Peak current (A)              | 5-315                          |

|                           |                  |
|---------------------------|------------------|
| Crater filler current (A) | 5-315            |
| Up-slope time (s)         | 0.2-10           |
| Down –slope time (s)      | 0.1-15           |
| Pre-gas flow time (s)     | 0.1-15           |
| Post-gas flow time (s)    | 0.1-60           |
| Pulse frequency (Hz)      | 0.2-20           |
| Pulse ratio               | 1-100%           |
| AC frequency (Hz)         | 20-200           |
| Pulse frequency (Hz)      | 0.2-20           |
| Pulse width               | 1-100%           |
| TIG mode                  | High frequency   |
| Arc force current (A)     | 10-200           |
| Dimension(mm )            | 655×325×560      |
| Weight(Kg)                | 55               |
| Isolation degree          | Main transformer |
|                           | Output reactor   |

Table 5-7-2: Power TIG 3200 AC/DC DC Pulse technical data –multi voltage



## 5-8 Main components list

### ● Power TIG 3200 AC/DC DC Pulse

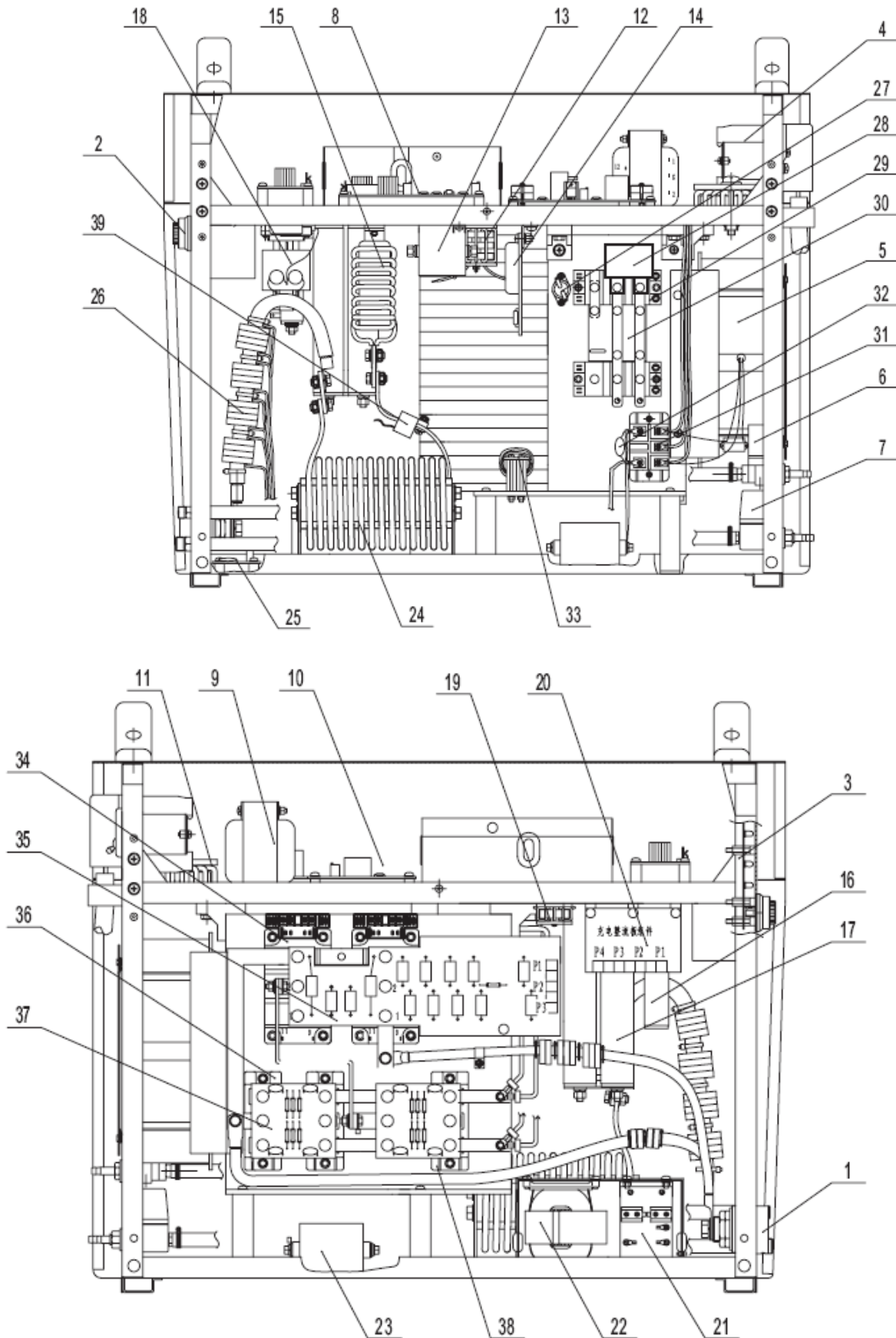

Fig. 5-8-1: Inner structure

| No. | Item                                      | Stock no.     | Remark    |
|-----|---|---------------|-----------|
| 1   | Quick plug                                | 740002-00038, | 380V/50Hz |
|     |   | 740002-00037, | 380V/50Hz |
| 2   | Potentiometer                             | 720031-00071, | 380V/50Hz |
| 3   | Display board                             | 220503-00018, | 380V/50Hz |
| 4   | Circuit breaker                           | 745011-00021, | 380V/50Hz |
| 5   | Fan                                       | 746001-00017, | 380V/50Hz |
|     |   | 746001-00034, | 400V/50Hz |
|     |   | 746001-00019, | 415V/50Hz |
| 6   | Solenoid valve                            | 752001-00007, | 380V/50Hz |
| 7   | Water flow switch                         | 745005-00003, | 380V/50Hz |
| 8   | Main control board                        | 210580-00111, | 380V/50Hz |
| 9   | Power transformer                         | 220179-00036, | 380V/50Hz |
|     |   | 220179-00604, | 400V/50Hz |
|     |   | 220179-00571, | 415V/50Hz |
| 10  | Drive board                               | 210310-00032, | 380V/50Hz |
| 11  | Input anti-common-mode inductor           | 220467-00011, | 380V/50Hz |
| 12  | Resonant inductor                         | 220521-00006, | 380V/50Hz |
| 13  | Polypropylene capacitor 4uf<br>500VAC     | 722001-00073, | 380V/50Hz |
| 14  | Current transformer                       | 220149-00028, | 380V/50Hz |
| 15  | Main transformer                          | 220629-00018  | 380V/50Hz |
| 16  | Wire-wound resistor 50W, 30Ω              | 720005-00028, | 380V/50Hz |
| 17  | Wire-wound resistor 200W, 20Ω             | 720006-00034, | 380V/50Hz |
| 18  | Isolation transformer                     | 763003-00023, | 380V/50Hz |
| 19  | Charging inductor                         | 220095-00001, | 380V/50Hz |
| 20  | Charging rectifier board                  | 220089-00004, | 380V/50Hz |
| 21  | Arc starting board                        | 220575-00003, | 380V/50Hz |
| 22  | High leakage reactance<br>transformer     | 763003-00018, | 380V/50Hz |
| 23  | Polypropylene capacitor 20uf<br>1400V     | 722001-00070, | 380V/50Hz |
| 24  | Output reactor                            | 763004-00112, | 380V/50Hz |
| 25  | Rack capacitor board                      | 220293-00023, | 380V/50Hz |
| 26  | Voltage boosting transformer              | 220431-00014, | 380V/50Hz |
| 27  | Temperature relay                         | 745008-00006, | 380V/50Hz |
| 28  | Polypropylene capacitor<br>0.47uf,1200VAC | 722001-00067, | 380V/50Hz |
| 29  | IGBT module                               | 735007-00046, | 380V/50Hz |
| 30  | IGBT protection board                     | 220005-00089, | 380V/50Hz |
| 31  | Three phase rectifier board               | 735005-00010, | 380V/50Hz |
| 32  | Varistor                                  | 720021-00017, | 380V/50Hz |
|     |   | 720021-00021, | 415V/50Hz |

|    |                                     |               |           |
|----|-------------------------------------|---------------|-----------|
| 33 | Current exchange inductor           | 220281-00008, | 380V/50Hz |
| 34 | Secondary IGBT components           | 220221-00001, | 380V/50Hz |
| 35 | Secondary IGBT protection board     | 220215-00001, | 380V/50Hz |
| 36 | Output diode module<br>MMF200S060DK | 735006-00055, | 380V/50Hz |
| 37 | Diode protection board              | 220233-00004, | 380V/50Hz |
| 38 | Output diode module<br>MMF200S060DA | 735006-00056, | 380V/50Hz |
| 39 | Current sensor                      | 753001-00023  | 380V/50Hz |

Table 5-8: Main components list

## 6-TROUBLE SHOOTING



**Notice!** The following troubles and causes are uncertain. However, during the welding process of Power TIG 3200 AC/DC DC Pulse and normal using conditions, these might happen.

| No. | Trouble   | Cause  | Remedy  |
|-----|---|--|---|
| 1   | Mains switch is ON, but indicators are not lit up                         | ●Default phase                                   | ●Check the components and circuit                                       |
|     |   | ●Fuse (2A) is broken                             | ●Check the fan, transformer, main control board                         |
|     |   | ●Line is broken                                  | ●Check mains supply lead  |
| 2   | The circuit breaker trips without working for a long time at high current | ●IGBT module or three phase rectifier is damaged | ●Check and replace  |
|     |   | ●Line-to-line short circuit                      | ●If IGBT is damaged, check 12Ω and 5.1Ω resistance SR160 on drive board |
| 3   | Unstable welding current  | ●Default phase                                   | ●Check power supply   |
|     |   | ●Main control board is damaged                   | ●Check and replace main control board                                   |
| 4   | The welding current is not adjustable                                     | ●Inner line is broken                            | ●Check and replace  |
|     |   | ●Main control board is damaged                   |   |
|     |   | ●Pedal switch is damaged                         |   |
| 5   | Over-voltage protection,  | ●Welding current is too high                     | ●Shut down the power source and   |

|   |   |  |   |
|---|---|--|---|
|   | E04 (or 804)                            | <ul style="list-style-type: none"> <li>• Too high temperature</li> <li>• Temperature relay is damaged</li> </ul>   | <ul style="list-style-type: none"> <li>wait for cooling</li> <li>• Replace temperature relay</li> </ul>                   |
| 6 | Torch switch abnormal, E02 (or 805)     | <ul style="list-style-type: none"> <li>• Pressing the torch switch for long time without current output</li> <li>• Torch switch (pedal switch) is damaged</li> </ul> | <ul style="list-style-type: none"> <li>• Release torch switch</li> <li>• Check or replace torch (pedal switch)</li> </ul> |
| 7 | Water-cooling is abnormal, E09 (or 806) | <ul style="list-style-type: none"> <li>• Water circulating system is not in good condition, such as water tank, water flow switch, torch</li> </ul>                  | <ul style="list-style-type: none"> <li>• Repair water tank, water flow switch and torch</li> </ul>                        |

Table 6: Trouble shooting

## 7-CARE AND MAINTENANCE

### Before open the machine



**Warning!** An electric shock can be fatal. Before opening up the machine

- Switch off the machine
- Disconnect the machine from the mains;
- Put up an easy-to-understand warning sign to stop anybody inadvertently switching it back on again;
- Using a suitable measuring instrument, check electrically charged components have been discharged.

### Maintenance of welding power source

Please follow the instructions as below to ensure normal use of power source

- Conduct safety check at regular intervals (see “Safety rules”)
- Dismantle machine side panels and clean machine inside with clean and low-pressure compressed air by professional technician, not less than twice per year. Clean the components at a certain distance only
- If a lot of dust has accumulated, clean the cooling-air ducts

### Maintenance of water-cooled welding torch

For water-cooled welding torch:

- Check the connections of cooling system
- Check the coolant level and cleanliness (clean coolant only)
- Frequently check coolant’s backflow state

## Daily maintenance

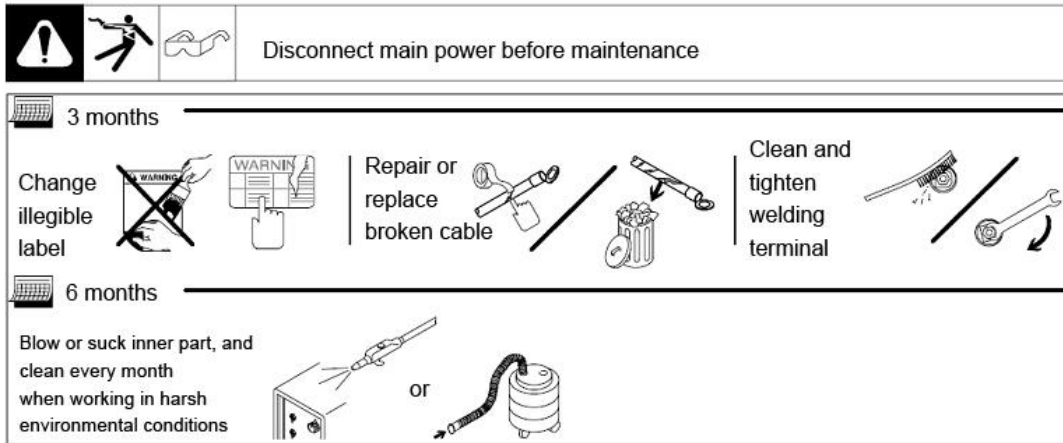

Fig. 7: Daily maintenance

## 8- WELDING TECHNIQUE GUIDE



**Note!** This section being general welding technique guide is for reference only. Specific functions of your machine please refer to previous chapters.

### 8-1 TIG (GTAW) basic welding technique

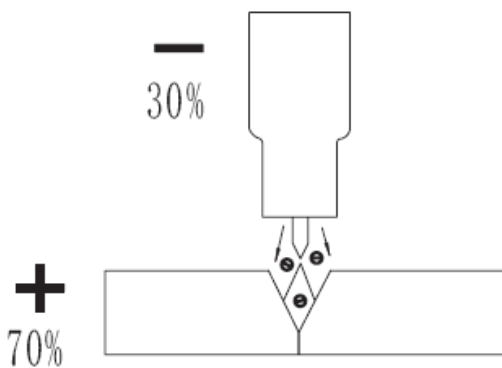

Fig. 8-1-1: Heat Input

The DC power source uses what is known as DC (direct current) in which the main electrical component known as electrons flow in only one direction from the negative pole (terminal) to the positive pole (terminal). In the DC electrical circuit there is an electrical principle at work which should always be taken into account when using any DC circuit. With a DC circuit 70% of the energy (heat) is always on the positive side. This needs to be understood because it determines what terminal the TIG torch will be connected to (this rule applies to all the other forms of DC welding as well).

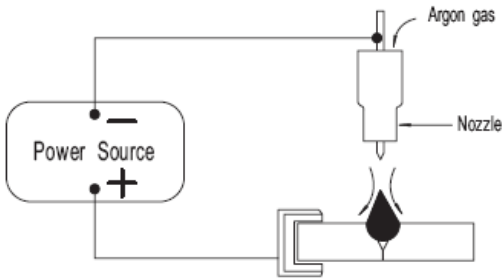

Fig. 8-1-2: TIG ARC

DC TIG welding is a process in which an arc is struck between a TUNGSTEN electrode and the metal work piece. The weld area is shielded by an inert gas flow to prevent contamination of the tungsten, molten pool and weld area. When the TIG arc is struck the inert gas is ionized and superheated changing it's molecular structure which converts it into a plasma stream. This plasma stream flowing between the tungsten and the work piece is the TIG arc and can be as hot as 9000K+. It is a very pure and concentrated arc which provides the controlled melting of most metals into a weld pool. TIG welding offers the user the greatest amount of flexibility to weld the widest range of material and thickness and types. DC TIG welding is also the cleanest weld with no sparks or spatter.

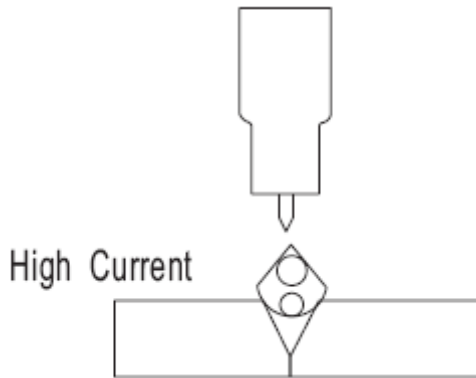

Fig. 8-1-3: Low current

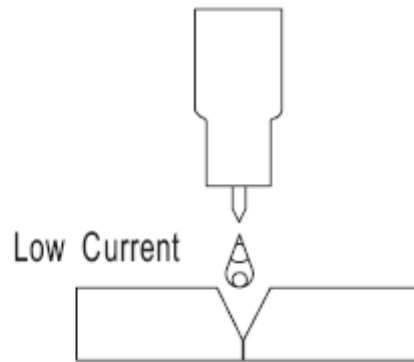

Fig. 8-1-4: High current

The intensity of the arc is proportional to the current that flows from the tungsten. The welder regulates the welding current to adjust the power of the arc. Typically thin material requires a less powerful arc with less heat to melt the material so less current (amps) is required, thicker material requires a more powerful arc with more heat so more current (amps) are necessary to melt the material.

#### LIFT ARC IGNITION for TIG (tungsten inert gas) Welding

Lift Arc is a form of arc ignition where the machines has low voltage on the electrode to only a few volts, with a current limit of one or two amps (well below the limit that causes metal to transfer and contamination of the weld or electrode). When the machine detects that the tungsten has left the surface and a spark is present, it immediately (within microseconds) increases power, converting the spark to a full arc. It is a simple, safe lower cost alternative arc ignition process to HF (high frequency) and a superior arc start process to scratch start.

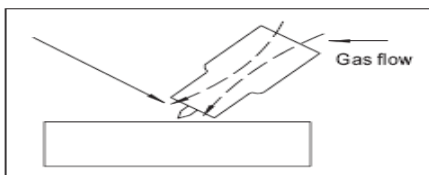

Fig. 8-1-5: Tungsten off the Work

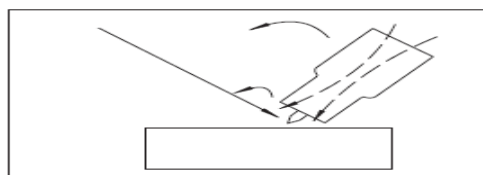

Fig. 8-1-6: Tungsten Touches the Work

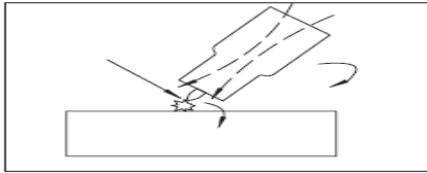

Fig. 8-1-7: Arc Ignition

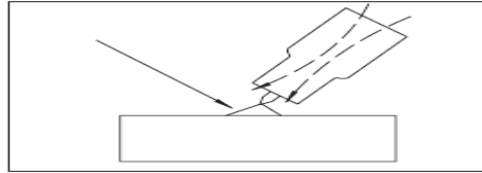

Fig. 8-1-8: Established TIG Arc

TIG Welding Fusion Technique

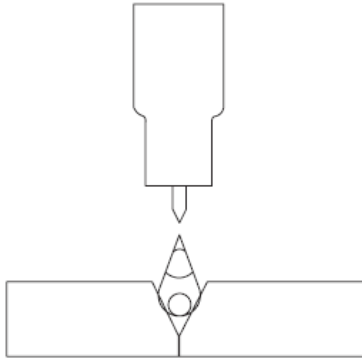

Fig. 8-1-9: TIG Arc

Manual TIG welding is often considered the most difficult of all the welding processes. Because the welder must maintain a short arc length, great care and skill are required to prevent contact between the electrode and the workpiece. Similar to Oxygen Acetylene torch welding, TIG welding normally requires two hands and in most instances requires the welder to manually feed a filler wire into the weld pool with one hand while manipulating the welding torch in the other. However, some welds combining thin materials can be accomplished without filler metal like edge, corner, and butt joints. This is known as Fusion welding where the edges of the metal pieces are melted together using only the heat and arc force generated by the TIG arc. Once the arc is started the torch tungsten is held in place until a weld pool is created, a circular movement of the tungsten will assist in creating a weld pool of the desired size. Once the weld pool is established tilt the torch at about a 75° angle and move smoothly and evenly along the joint while fusing the materials together.

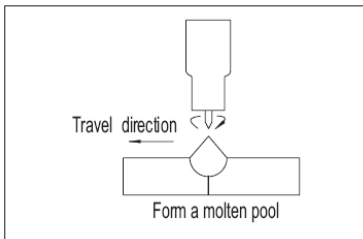

Fig. 8-1-10: Form a Weld Pool

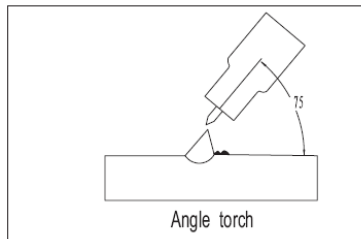

Fig. 8-1-11: Angle Torch

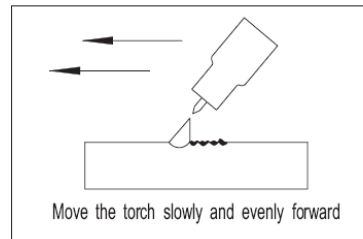

Fig. 8-1-12: Torch Move

TIG Welding with Filler Wire Technique

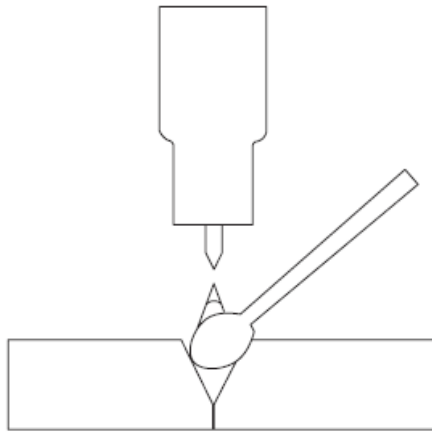

Fig. 8-1-13: Add TIG Filler Wire

It is necessary in many situations with TIG welding to add a filler wire into the weld pool to build up weld reinforcement and create a strong weld. Once the arc is started the torch tungsten is held in place until a weld pool is created, a circular movement of the tungsten will assist in creating a weld pool of the desired size. Once the weld pool is established tilt the torch at about a  $75^\circ$  angle and move smoothly and evenly along the joint. The filler metal is introduced to the leading edge of the weld pool. The filler wire is usually held at about a  $15^\circ$  angle and fed into the leading edge of the molten pool, the arc will melt the filler wire into the weld pool as the torch is moved forward. Also a dabbing technique can be used to control the amount of filler wire added, the wire is fed into the molten pool and retracted in a repeating sequence as the torch is moved slowly and evenly forward. It is important during the welding to keep the molten end of the filler wire inside the gas shield as this protects the end of the wire from being oxidised and contaminating the weld pool.

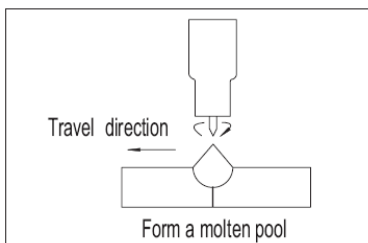

Fig. 8-1-14: Form a Weld Pool

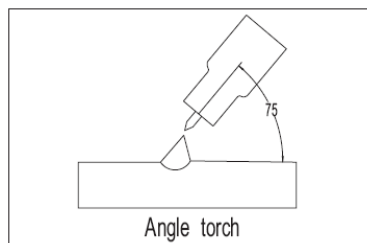

Fig. 8-1-15: Angle Torch

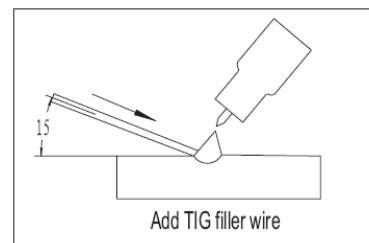

Fig. 8-1-16: Add TIG Filler Wire

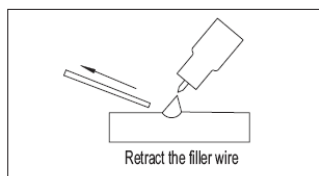

Fig. 8-1-17: Retract the Filler Wire

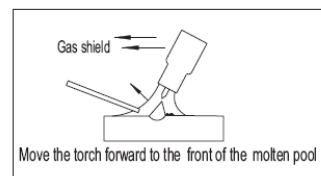

Fig. 8-1-18: Torch Move

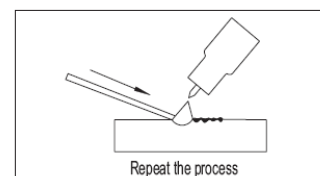

Fig. 8-1-19: Repeat the Process

### Tungsten Electrodes

Tungsten is a rare metallic element used for manufacturing TIG welding electrodes. The TIG process relies on tungsten's hardness and high-temperature resistance to carry the welding current to the arc. Tungsten has the highest melting point of any metal, 3,410 degrees Celsius.

Tungsten electrodes are nonconsumable and come in a variety of sizes, they are made from pure tungsten or an alloy of tungsten and other rare earth elements. Choosing the correct tungsten depends on the material being welded, the amount of amps required and whether you are using AC or DC welding current.

Follow are common used tungsten types: Thoriated, Ceriated, Lanthanated, Zirconiated



Table 8-1-1: Tungsten Electrodes Rating for Welding Currents

| Tungsten Diameter<br>mm | DC Current<br>Amps<br>Torch Negative<br>2% Thoriated |
|-------------------------|--|
| 1.0mm                   | 15 - 80  |
| 1.6mm                   | 70 - 150   |
| 2.4mm                   | 150 - 250  |
| 3.2mm                   | 250 - 400  |
| 4.0mm                   | 400 - 500  |

### Tungsten Preparation

Always use DIAMOND wheels when grinding and cutting. While tungsten is a very hard material, the surface of a diamond wheel is harder, and this makes for smooth grinding. Grinding without diamond wheels, such as aluminium oxide wheels, can lead to jagged edges, imperfections, or poor surface finishes not visible to the eye that will contribute to weld inconsistency and weld defects.

Always ensure to grind the tungsten in a longitudinal direction on the grinding wheel. Tungsten electrodes are manufactured with the molecular structure of the grain running lengthwise and thus grinding crosswise is “grinding against the grain.” If electrodes are ground crosswise, the electrons have to jump across the grinding marks and the arc can start before the tip and wander. Grinding longitudinally with the grain, the electrons flow steadily and easily to the end of the tungsten tip. The arc starts straight and remains narrow, concentrated, and stable.

Table 8-1-2: Tungsten Diameter Rating for Angle and Current

| Tungsten Diameter | Constant Included Angle<br>- Degrees | Current Range<br>Amps |
|-------------------|--------------------------------------|-----------------------|
| 1.0mm             | 20                                   | 05 - 30               |
| 1.6mm             | 25                                   | 08 - 50               |
| 1.6mm             | 30                                   | 10 - 70               |
| 2.4mm             | 35                                   | 12 - 90               |
| 2.4mm             | 45                                   | 15 - 150              |
| 3.2mm             | 60                                   | 20 - 200              |
| 3.2mm             | 90                                   | 25 - 250              |

## 8-2 STICK (SMAW) basic welding technique

One of the most common types of arc welding is manual metal arc welding (MMA) or stick welding. An electric current is used to strike an arc between the base material and a consumable electrode rod or ‘stick’. The electrode rod is made of a material that is compatible with the base material being welded and is covered with a flux that gives off gaseous vapours that serve as a shielding gas and providing a layer of slag, both of which protect the weld area from atmospheric contamination. The electrode core itself acts as filler material the residue from the flux that forms a slag covering over the weld metal must be chipped away after welding.

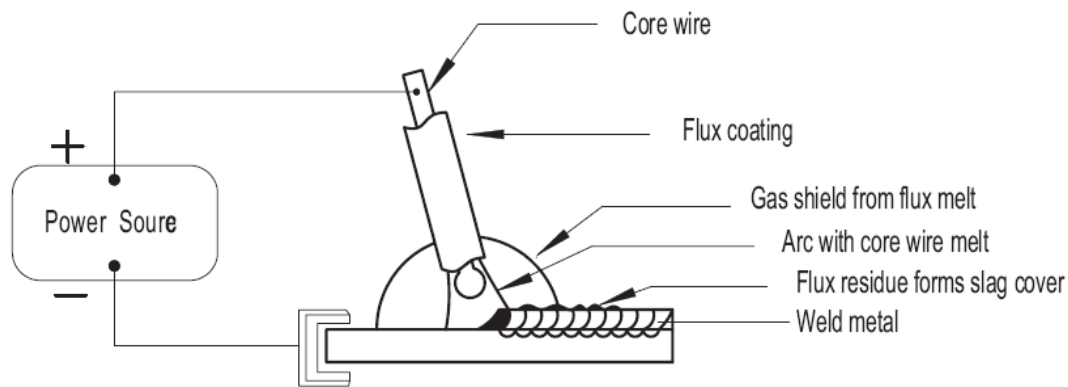

Fig. 8-2-1: Stick ARC

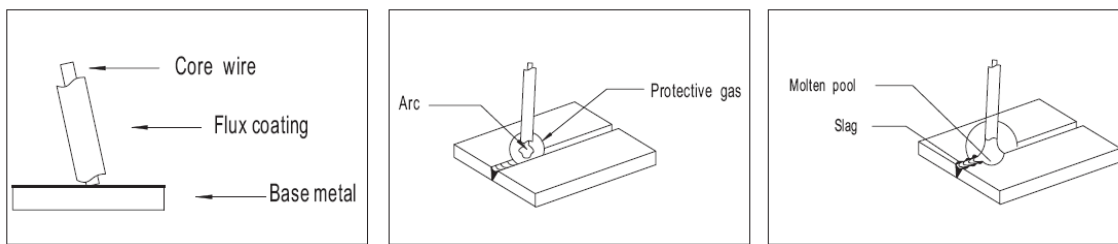

Fig. 8-2-2: ARC Ignition

Fig. 8-2-3: Weld pool Protection

Fig. 8-2-4: Slag

- The arc is initiated by momentarily touching the electrode to the base metal.
- The heat of the arc melts the surface of the base metal to form a molten pool at the end of the electrode.

- The melted electrode metal is transferred across the arc into the molten pool and becomes the deposited weld metal.
- The deposit is covered and protected by a slag which comes from the electrode coating.
- The arc and the immediate area are enveloped by an atmosphere of protective gas.

Manual metal arc (stick) electrodes have a solid metal wire core and a flux coating. These electrodes are identified by the wire diameter and by a series of letters and numbers. The letters and numbers identify the metal alloy and the intended use of the electrode.

The Metal Wire Core works as conductor of the current that maintains the arc. The core wire melts and is deposited into the welding pool.

The covering on a shielded metal arc welding electrode is called Flux.

The flux on the electrode performs many different functions.

These include:

- producing a protective gas around the weld area
- providing fluxing elements and deoxidizers
- creating a protective slag coating over the weld as it cools
- establishing arc characteristics
- adding alloying elements

Covered electrodes serve many purposes in addition to adding filler metal to the molten pool.

These additional functions are provided mainly by the covering on the electrode.

## MMA (Stick) Welding Fundamentals

### Electrode Selection

As a general rule, the selection of an electrode is straight forward, in that it is only a matter of selecting an electrode of similar composition to the parent metal. However, for some metals there is a choice of several electrodes, each of which has particular properties to suit specific classes of work. It is recommend to consult your welding supplier for the correct selection of electrode.

Table 8-2-1: Electrode Size

| Average Thickness of Material | Maximum Recommended Electrode Diameter |
|-------------------------------|--|
| 1.0 - 2.0mm                   | 2.5mm                                  |
| 2.0 - 5.0mm                   | 3.2mm                                  |
| 5.0 - 8.0mm                   | 4.0mm                                  |
| 8.0 - > mm                    | 5.0mm                                  |

The size of the electrode generally depends on the thickness of the section being welded, and the thicker the section the larger the electrode required. The table gives the maximum size of electrodes that maybe used for various thicknesses of section base on using a general purpose type 6013 electrode.

Table 8-2-2: Welding Current (Amperage)

| Electrode Size $\varnothing$ mm | Current Range (Amps) |
|---------------------------------|----------------------|
| 2.5mm                           | 60 - 95              |
| 3.2mm                           | 100 - 130            |
| 4.0mm                           | 130 - 165            |
| 5.0mm                           | 165 - 260            |

Correct current selection for a particular job is an important factor in arc welding. With the current set too low, difficulty is experienced in striking and maintaining a stable arc. The electrode tends to stick to the work, penetration is poor and beads with a distinct rounded profile will be deposited. Too high current is accompanied by overheating of the electrode resulting undercut and burning through of the base metal and producing excessive spatter. Normal current for a particular job may be considered as the

maximum, which can be used without burning through the work, over-heating the electrode or producing a rough spattered surface.

The table shows current ranges generally recommended for a general purpose type 6013 electrode.

### Arc Length

To strike the arc, the electrode should be gently scraped on the work until the arc is established. There is a simple rule for the proper arc length; it should be the shortest arc that gives a good surface to the weld. An arc too long reduces penetration, produces spatter and gives a rough surface finish to the weld. An excessively short arc will cause sticking of the electrode and result in poor quality welds. General rule of thumb for down hand welding is to have an arc length no greater than the diameter of the core wire.

### Electrode Angle

The angle that the electrode makes with the work is important to ensure a smooth, even transfer of metal. When welding in down hand, fillet, horizontal or overhead the angle of the electrode is generally between 5 and 15 degrees towards the direction of travel. When vertical up welding the angle of the electrode should be between 80 and 90 degrees to the work piece.

### Travel Speed

The electrode should be moved along in the direction of the joint being welded at a speed that will give the size of run required. At the same time, the electrode is fed downwards to keep the correct arc length at all times. Excessive travel speeds lead to poor fusion, lack of penetration etc, while too slow a rate of travel will frequently lead to arc instability, slag inclusions and poor mechanical properties.

### Material and Joint Preparation

The material to be welded should be clean and free of any moisture, paint, oil, grease, mill scale, rust or any other material that will hinder the arc and contaminate the weld material. Joint preparation will depend on the method used include sawing, punching, shearing, machining, flame cutting and others. In all cases edges should be clean and free of any contaminates. The type of joint will be determined by the chosen application.

# Power TIG Series



**GeKaMac**<sup>®</sup>



**Gedik Welding Inc.**

Ankara Caddesi No: 306 Şeyhli 34906 Pendik - İstanbul / Turkey

P. +90 216 378 50 00 • F. +90 216 378 20 44

[www.gedikwelding.com](http://www.gedikwelding.com)